



8. fejezet

Fogantyúk, fogasok

Tartalomjegyzék

8.3	Gola profilrendszer
8.11	Fogantyúprofilok
8.12	Bútorfogantyúk
8.192	Fogasok, fogassorok
8.227	Bútorfogantyúk és fogasok cikkszám táblázata
8.236	Díszlécek, díszidomok

Útmutató

A termék jelölése: **Terméknév**

Cikkszám jelölése: 10012500101

Figyelem!

A bútorfogantyúkat és fogasokat ábrázoló méretezett műszaki rajzok az adott termék befoglaló méretei, illetve a furattávolságok tekintetében adnak pontos információt. A termék formai megjelenése csak tájékoztató jellegű.

A gyártók folyamatos termékfejlesztése következtében termékeink kismértékben módosulhatnak a katalógusban megjelenő képektől. A termékek nem szakszerű beszereléséből adódó károkért felelősséget nem vállalunk.

Amennyiben a katalógusban látható színek, színminták és a termékek valódi színe esetében némi eltérés tapasztalható, ez a nyomdai technológia és az alkalmazott anyagok jellegéből adódhat. Az esetleges nyomdai hibákért felelősséget nem vállalunk!

Jelmagyarázat:



Fémből készült termék



Műanyagból készült termék



Gumiból készült termék



Tömörfából készült termék



Porcelánból készült termék



Nemesacél, rozsdamentes inox alapanyag



Exkluzív • Magas minőségű, igényes formatervezésű termék.



Legkedvezőbb ár • Kínálatunk legolcsóbb terméke az adott kategóriában.



Kiváló ár-érték arány • Kedvező árfekvésű, jó minőséget képviselő termék.

GOLA

ALUMÍNIUM FOGANTYÚPROFIL RENDSZER

Minimál stílusú bútor kialakítása során akár el is tekinthetünk a fogantyúk alkalmazásától.

A Gola alumínium profilrendszert használva a fogantyú nem töri meg a látvány szempontjából a frontot, hanem a horizontális elrendezést hangsúlyozva, a szekrényelemeken végigfutó vízszintes, illetve bizonyos esetekben függőleges alumínium mélyedésként jelenik meg. Itt lehet az ajtókat és a fiókelőket megfogni a kinyitáshoz.



Gola profilrendszer, fogantyú nélküli megoldásokhoz



Gola felső profil

anyag: alumínium
rendelhető 4200 mm-es szálban

10000691000

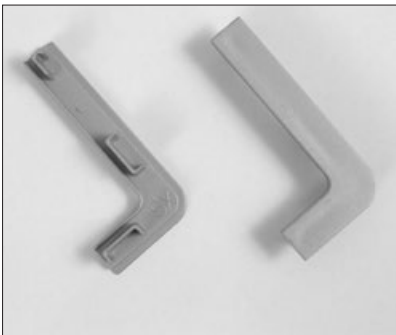
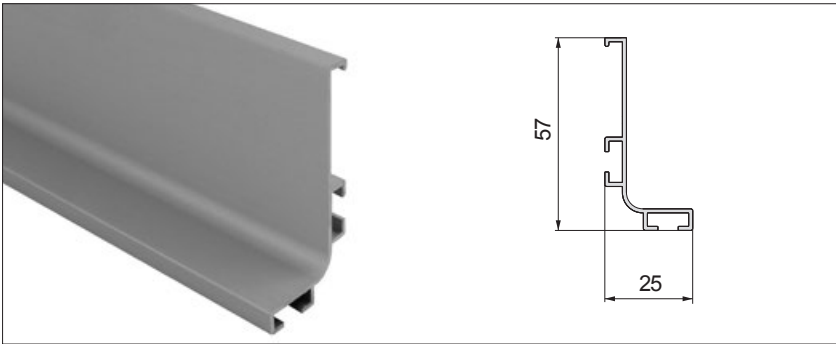
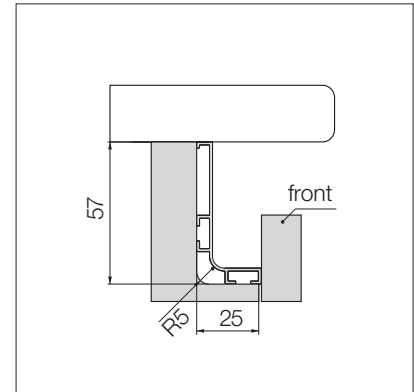

Külső végzáró felső szett

anyag: műanyag

10000691010



Külső végzáró felső szett

anyag: alumínium

10000691020



Belső végzáró felső szett

anyag: műanyag

10000691030

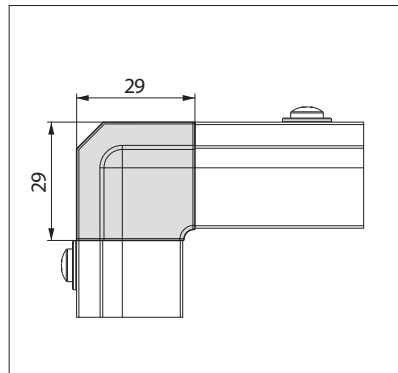
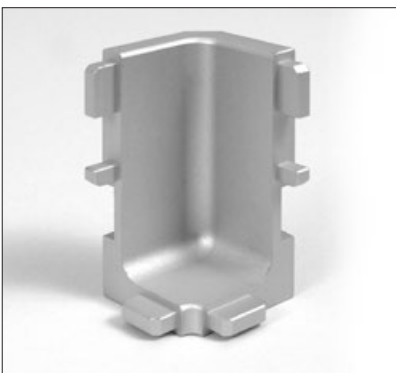

Belső sarok felső profilhoz

anyag: alumínium

10000691040

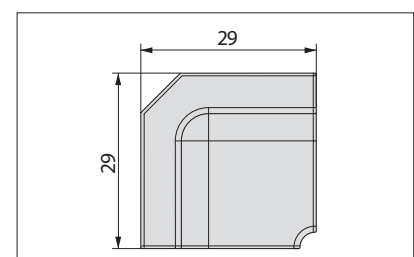

Gola profilrendszer, fogantyú nélküli megoldásokhoz

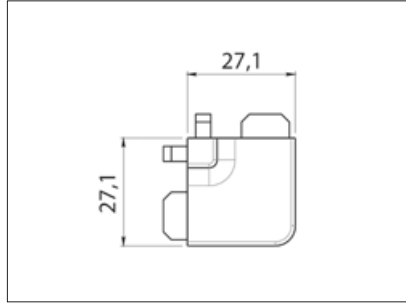

Gola külső sarok felső profilhoz

anyag: alumínium

10000691050

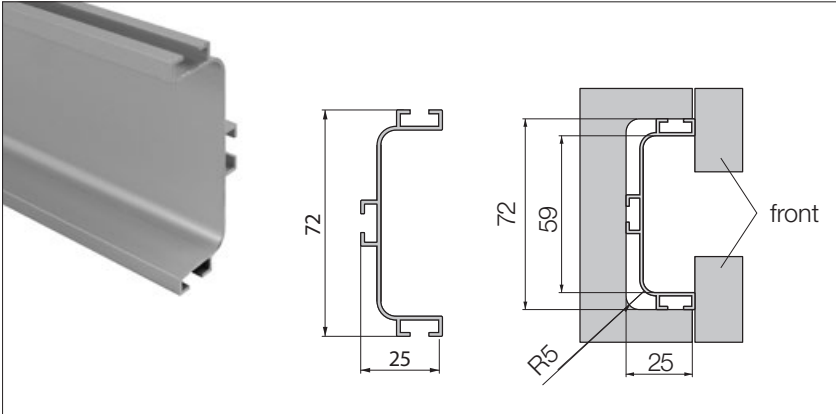

Gola közbenső profil

anyag: alumínium

rendelhető 4200 mm-es szálban

10000691100



Külső végzáró közbenső szett

anyag: műanyag

10000691110



Külső végzáró közbenső szett

anyag: alumínium

10000691120



Belső végzáró közbenső szett

anyag: műanyag

10000691130

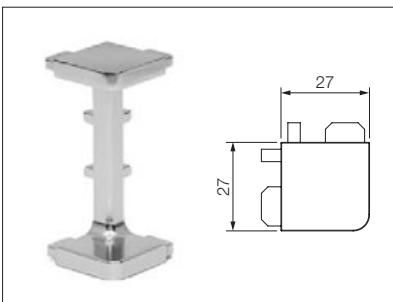

Gola külső sarok közbenső profilhoz

anyag: alumínium

10000691140



Gola profilrendszer, fogantyú nélküli megoldásokhoz

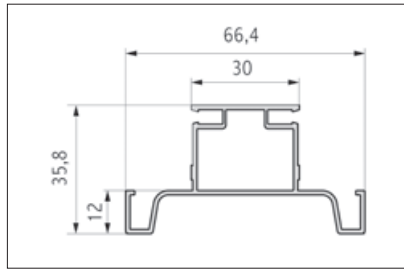
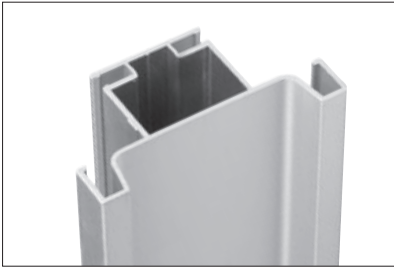

Gola függőleges dupla profil

anyag: alumínium
endelhető 4700 mm-es szálaban

10000691300

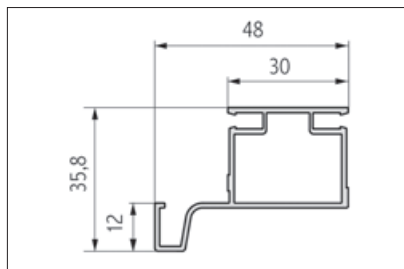

Gola függőleges szimpla profil

anyag: alumínium
endelhető 4700 mm-es szálaban

10000691310

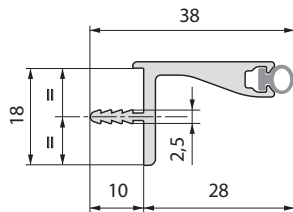
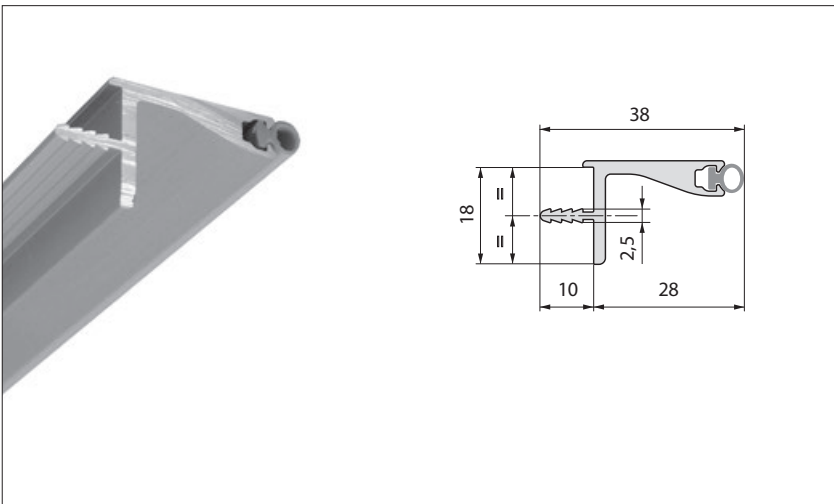

Gola felsőszekrény vízszintes profil

anyag: alumínium
ütközéscsillapító gumi csikkal
rendelhető 4200 mm-es szálaban

10000691200

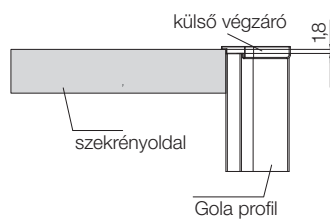
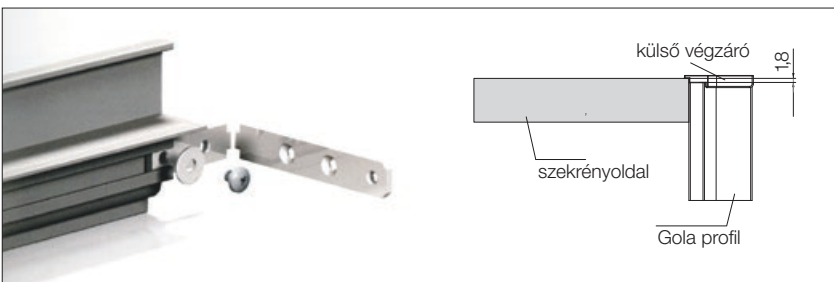
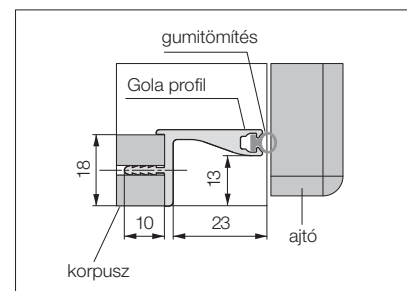

Szerelési segédlet Gola profilokhoz

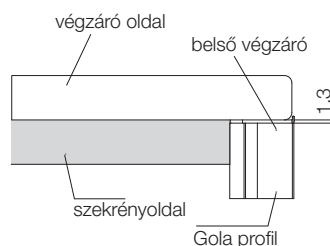
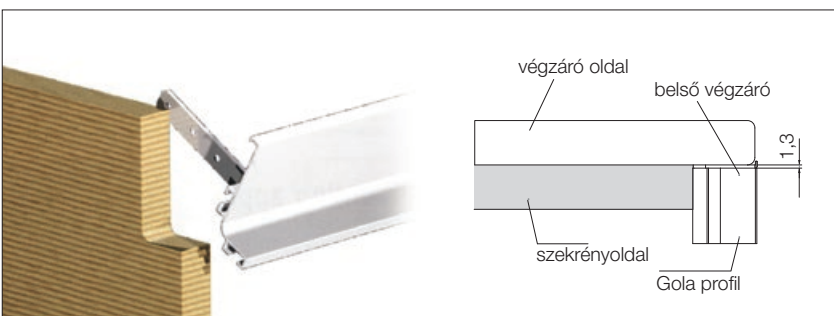

Rögzítőlemez csavarral

felső és közbenső profilokhoz
A garnitúra 2 db rögzítőlemezt tartalmaz

10000691990

Gola Clap'n'Fit profilrendszer, fogantyú nélküli megoldásokhoz

Clap'n'Fit

A nemzetközi szabalommal védett, új Gola rendszer több előnyt is kínál:

- gyors és egyszerű rögzítés egyetlen szerszám segítségével
- két profillal az összes front nyitása megoldható
- függőlegesen és vízszintesen egyaránt alkalmazható
- ergonomiailag továbbfejlesztett forma

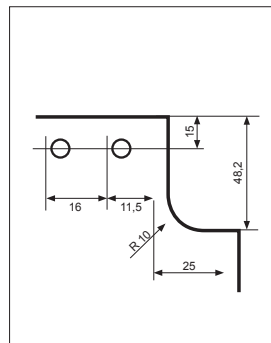
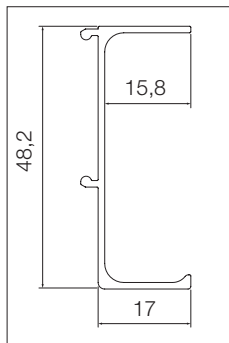
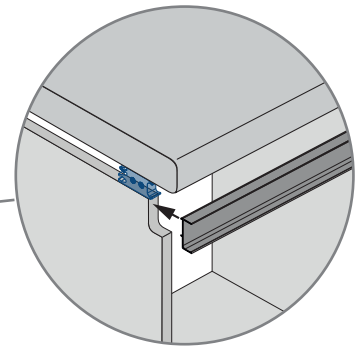
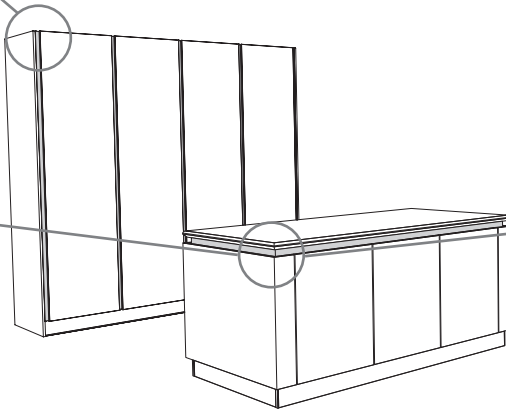
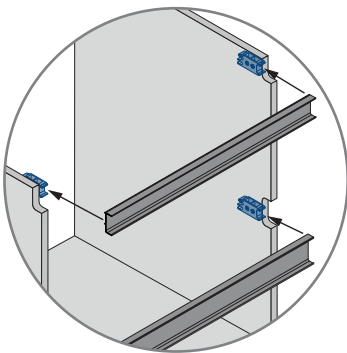
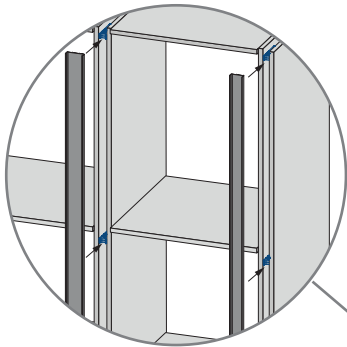

Gola Clap'n'Fit szimpla profil

egy ajtófront nyitásához
anyag: alumínium
rendelhető 4.200 mm-es szálban

szín	cikkszám
alumínium	10000692000
fehér	10000692010
fekete	10000692020

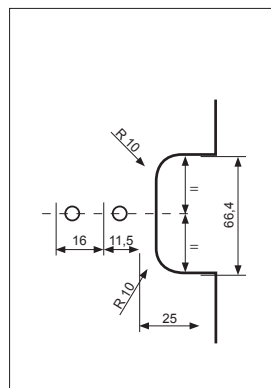
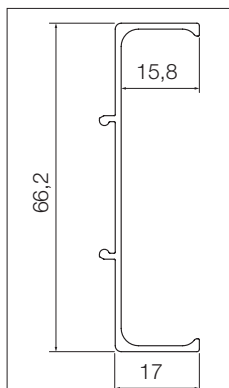

Gola Clap'n'Fit dupla profil

két front nyitásához
anyag: alumínium
rendelhető 4.200 mm-es szálban

szín	cikkszám
alumínium	10000692050
fehér	10000692060
fekete	10000692070

Gola Clap'n'Fit profilrendszer, fogantyú nélküli megoldásokhoz

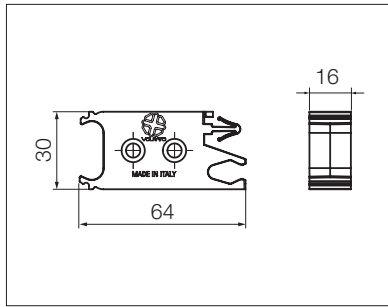

Gola Clap'n'Fit függesztő elem

kiszerezés: 10 db/csomag

10000692100

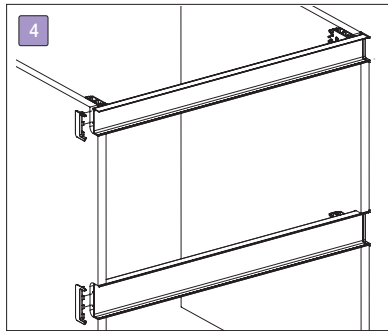
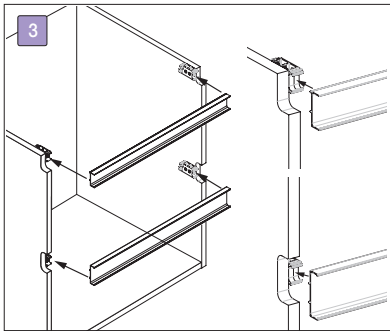
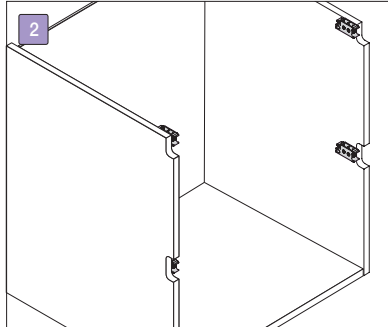
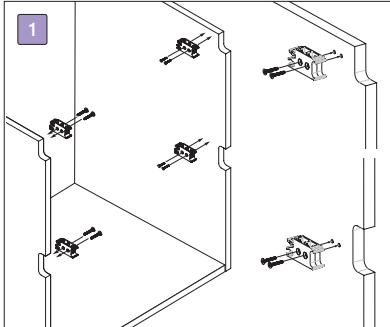

Vízszintes elemek kialakítása a függesztő elem segítségével

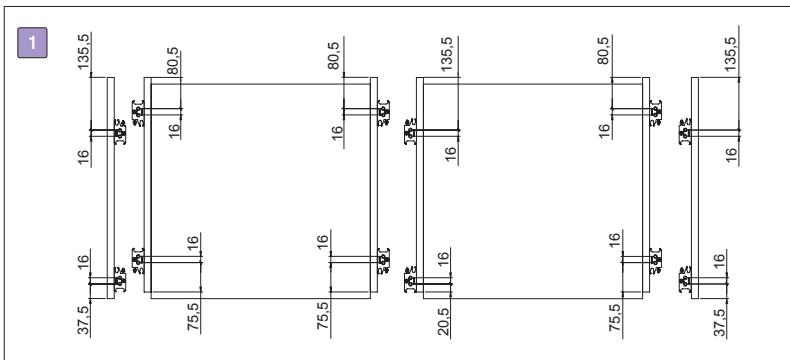

Függőleges elemekhez történő elemek alkalmazása esetén a függesztő elem megkönnyíti az elemek egymáshoz sorolását.

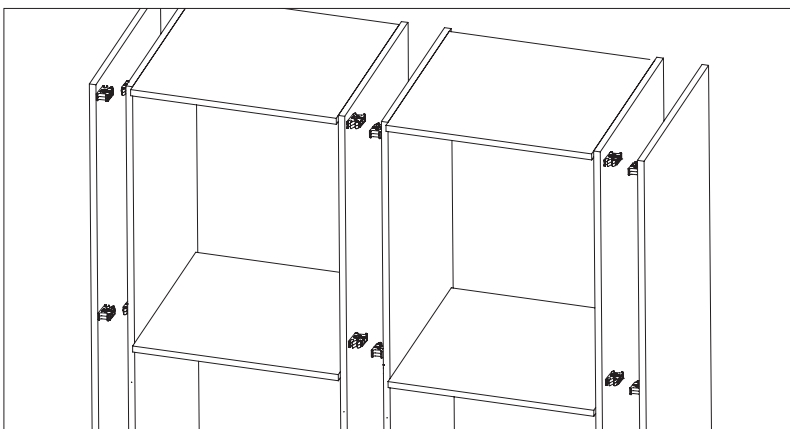
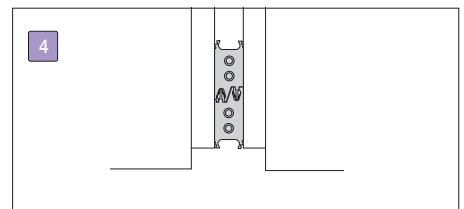
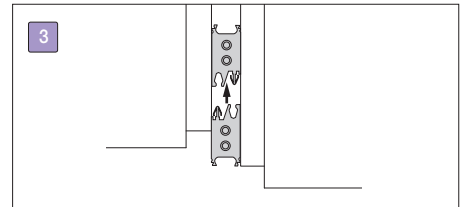
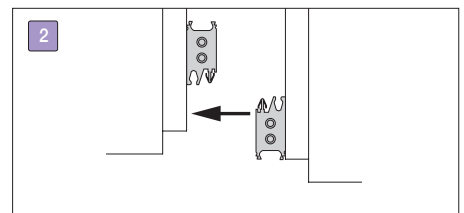

Gola Clap'n'Fit profilrendszer, fogantyú nélküli megoldásokhoz

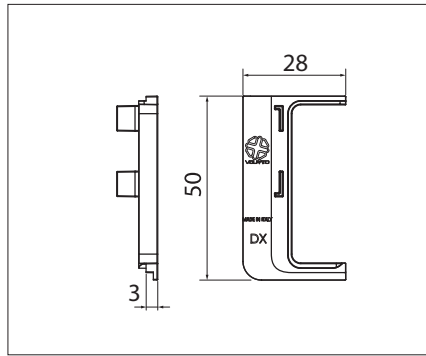

Gola Clap'n'Fit külső végzáró szimpla profilhoz

anyag: műanyag
rendelhető: párban

szín	cikkszám
alumínium	10000692200
fehér	10000692220
fekete	10000692210

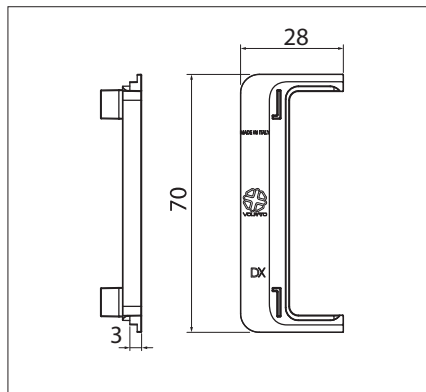

Gola Clap'n'Fit külső végzáró dupla profilhoz

anyag: műanyag
rendelhető: párban

szín	cikkszám
alumínium	10000692205
fehér	10000692225
fekete	10000692215

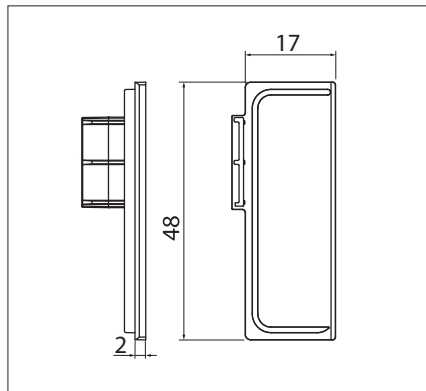

Gola Clap'n'Fit belső végzáró szimpla profilhoz

anyag: műanyag
rendelhető: párban

szín	cikkszám
alumínium	10000692250
fehér	10000692270
fekete	10000692260

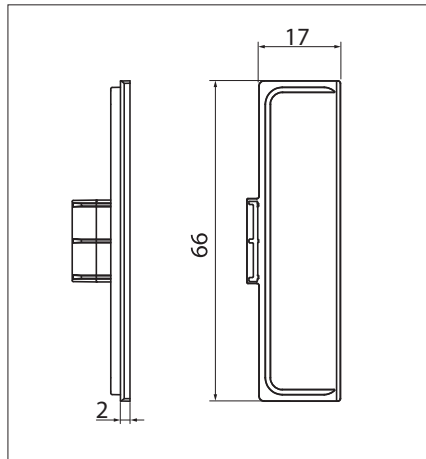

Gola Clap'n'Fit belső végzáró dupla profilhoz

anyag: műanyag
rendelhető: párban

szín	cikkszám
alumínium	10000692255
fehér	10000692275
fekete	10000692265

Gola Clap'n'Fit profilrendszer, fogantyú nélküli megoldásokhoz

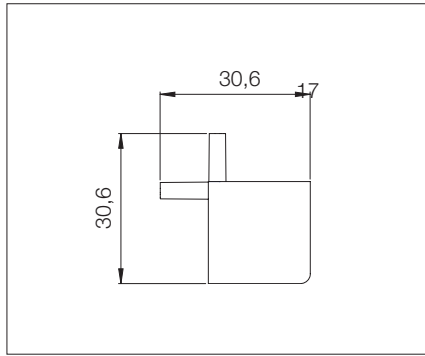

Gola Clap'n'Fit külső sarok szimpla profilhoz

anyag: műanyag
rendelhető: párban

szín	cikkszám
alumínium	10000692300
fehér	10000692340
fekete	10000692320

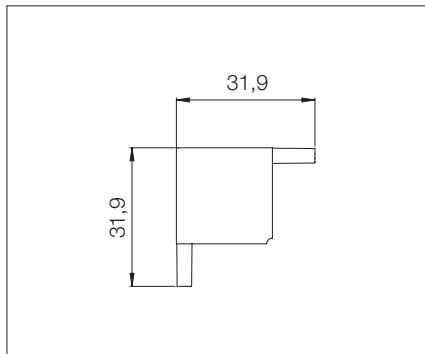

Gola Clap'n'Fit belső sarok szimpla profilhoz

anyag: műanyag
rendelhető: párban

szín	cikkszám
alumínium	10000692310
fehér	10000692350
fekete	10000692330

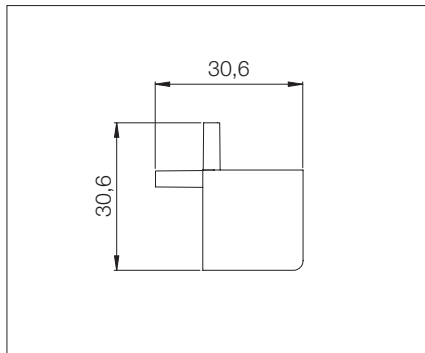

Gola Clap'n'Fit külső sarok dupla profilhoz

anyag: műanyag
rendelhető: párban

szín	cikkszám
alumínium	10000692305
fehér	10000692345
fekete	10000692325

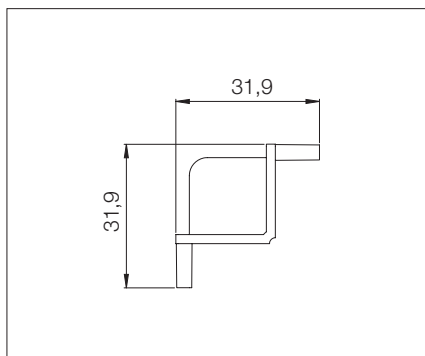
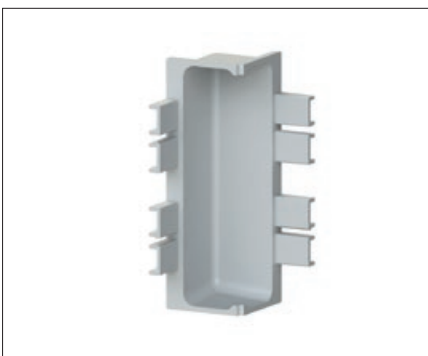

Gola Clap'n'Fit belső sarok dupla profilhoz

anyag: műanyag
rendelhető: párban

szín	cikkszám
alumínium	10000692315
fehér	10000692355
fekete	10000692335

Fogantyúprofilok

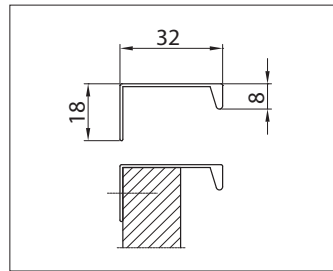
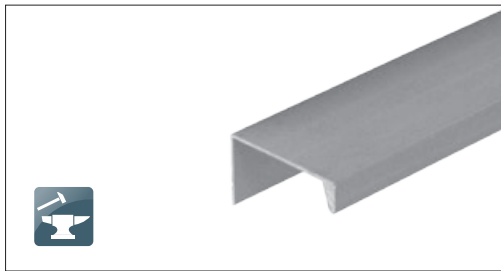
L 806A
alumínium fogantyúprofil

Rendelhető 3 fm-es szálban.
 Fiókok szerelésére alkalmas.
 Nyíló ajtók felső-, ill. alsó élére szerelve csak speciális pánt segítségével alkalmazható.

10000652200

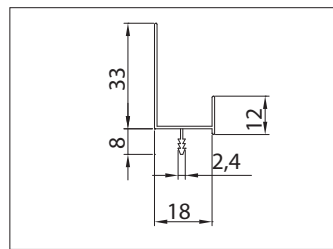
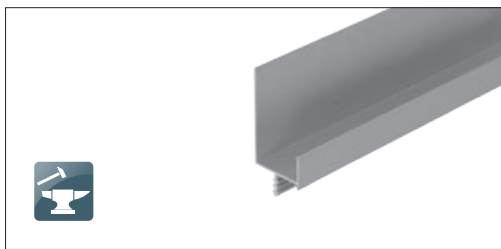
L 807A
alumínium fogantyúprofil

Rendelhető 3 fm-es szálban.
 Hagyományos nyíló- és bukóajtók, valamint fiókok szerelésére alkalmas.

10000652210

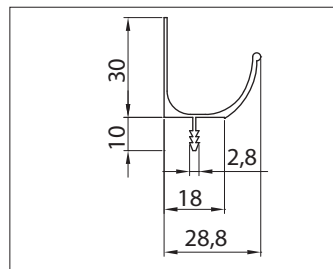
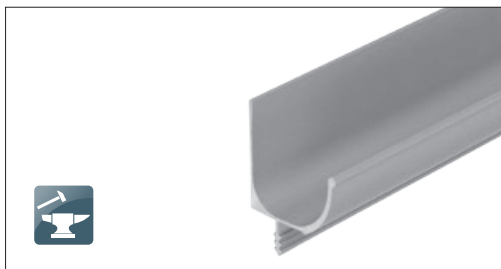
L 808A
alumínium fogantyúprofil

Rendelhető 3 fm-es szálban.
 Fiókok szerelésére alkalmas.
 Nyíló ajtók felső-, ill. alsó élére szerelve csak speciális pánt segítségével alkalmazható.

10000652220

A működtetéshez szükséges speciális pánt ezen az oldalon található:

9.24



A028 - fém / alumínium



méret (mm)	cikkszám
295	10007653440
395	10007653450
445	10007653453
495	10007653456
595	10007653460
795	10007653463
895	10007653466

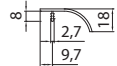
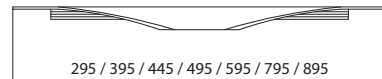
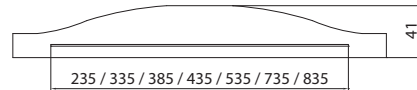

A027 - fém / alumínium



méret (mm)	cikkszám
295	10007653410
395	10007653420
445	10007653423
495	10007653426
595	10007653430
795	10007653433
895	10007653436

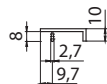
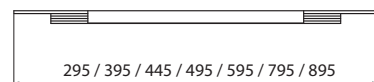
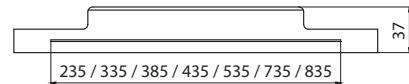

A064 - fém - rozsdamentes acél

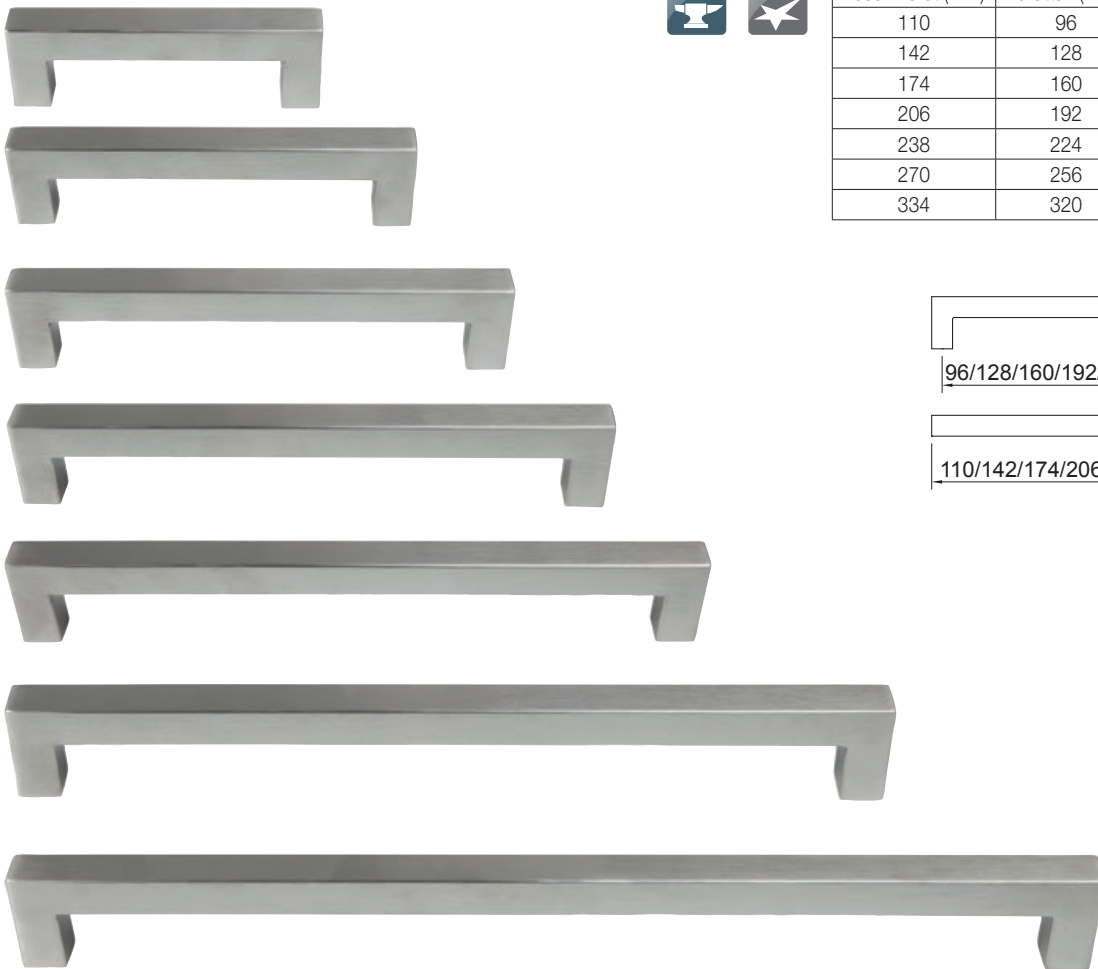

hosszméret (mm)	furattáv (mm)	cikkszám
110	96	10007652280
142	128	10007652290
174	160	10007652300
206	192	10007652310
238	224	10007652320
270	256	10007652330
334	320	10007652340

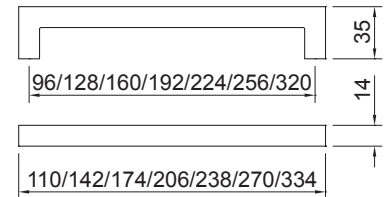

■ 1406 inox - rozsdamentes acél

S I R O[®]
www.siro.cc

hosszméret (mm)	furattáv (mm)	cikkszám
108	96	10007310200
140	128	10007310210
172	160	10007310220

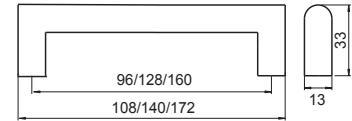

■ 902-24 inox - rozsdamentes acél



méret	cikkszám
D: 24 mm, H: 29 mm	10007310040

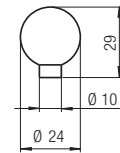

■ 904-12 inox - rozsdamentes acél



méret	cikkszám
D: 12 mm, H: 21,5 mm	10007310050

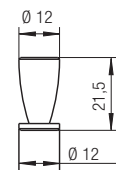

■ 1404-18 inox - rozsdamentes acél



méret	cikkszám
D: 18 mm, H: 24 mm	10007310060

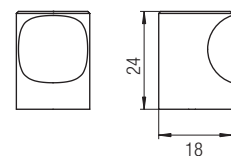

2279-18 inox - rozsdamentes acél



méret	cikkszám
D: 18 mm, H: 15 mm	10007310360

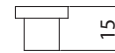
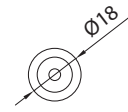

2277-10 inox - rozsdamentes acél



méret	cikkszám
10x10x22 mm	10007310350

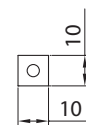

901 inox - rozsdamentes acél



hosszméret (mm)	furattáv (mm)	cikkszám
74	64	10007310100
106	96	10007310110
138	128	10007310120
170	160	10007310130

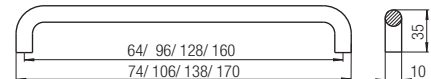

2418 inox - rozsdamentes acél



méret	cikkszám
D: 20 mm, H: 45 mm	10007310070

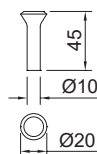

2419 inox - rozsdamentes acél



méret	cikkszám
D: 20 mm, H: 28 mm	10007310080
D: 25 mm, H: 28 mm	10007310090

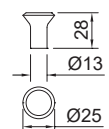
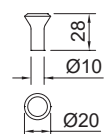



1585 inox - rozsdamentes acél



hosszméret (mm)	furattáv (mm)	cikkszám
143	128	10007310000
175	160	10007310010
207	192	10007310020
335	320	10007310030

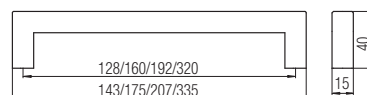

1407 inox - rozsdamentes acél



hosszméret (mm)	furattáv (mm)	cikkszám
148	96	10007310300
184	128	10007310310
216	160	10007310320
248	192	10007310330
344	288	10007310340

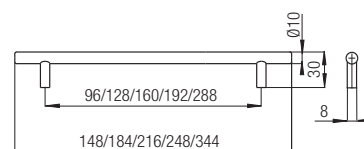

885 - fém / matt nikkel

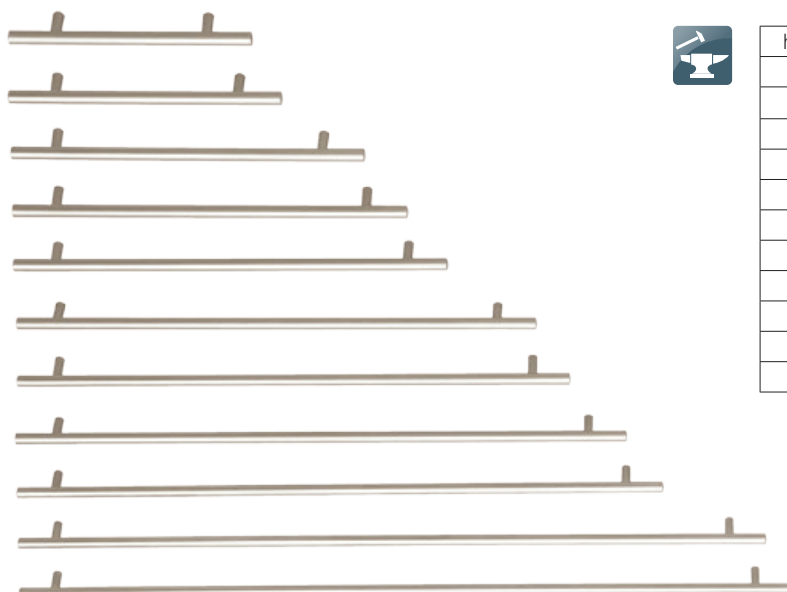
S I R O[®]
www.siro.cc

hosszméret (mm)	furattáv (mm)	cikkszám
208	128	10007303800
240	160	10007303810
320	240	10007303820
368	288	10007303830
416	336	10007303840
512	432	10007303850
559	480	10007303860
635	552	10007303870
688	608	10007303880
816	736	10007303890
863	784	10007303900

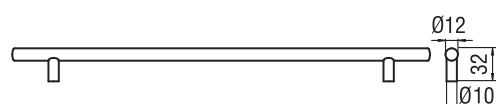

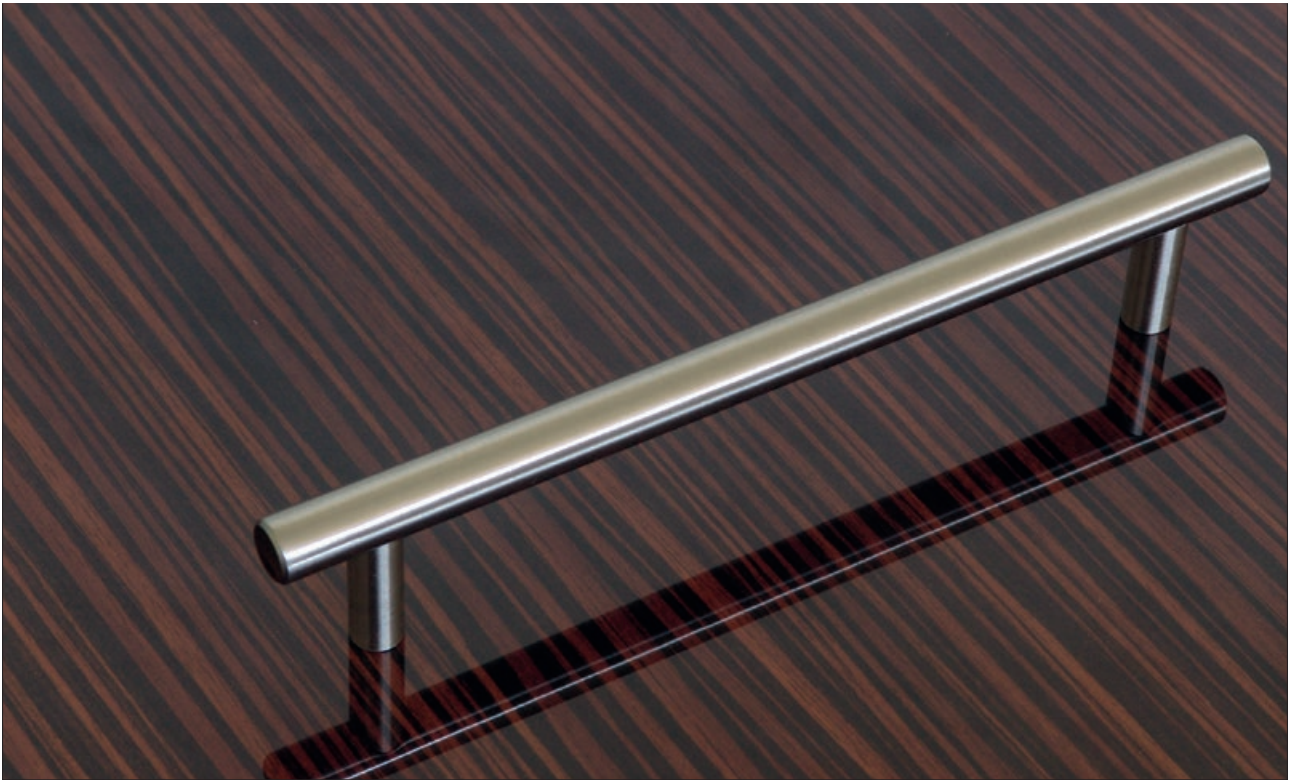

E037 - fém

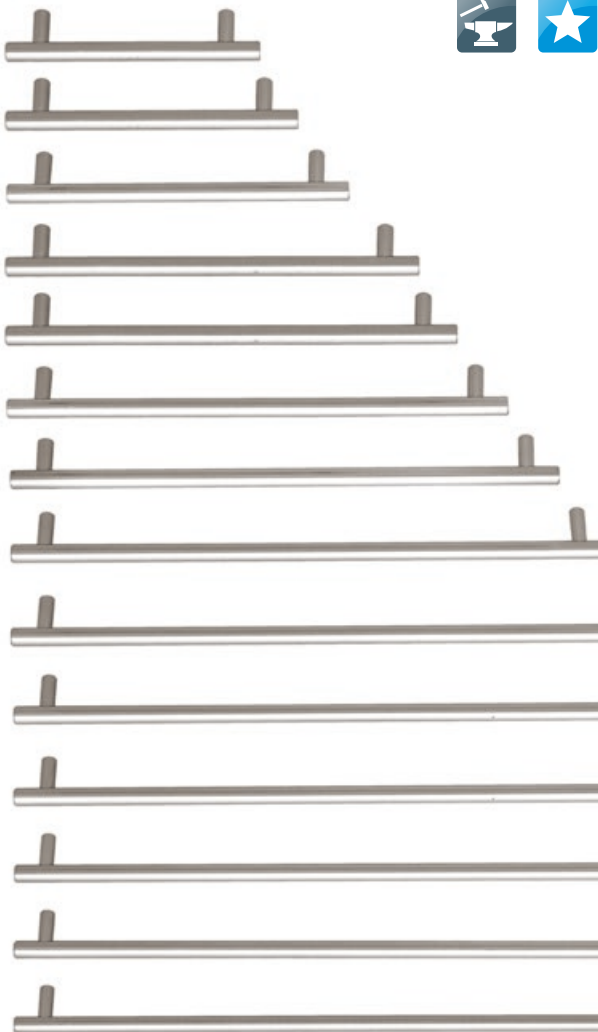

hosszméret (mm)	furattáv (mm)	nikkel	króm
136	96	10007650876	10007650834
168	128	10007650880	10007650836
200	160	10007650890	10007650839
232	192	10007650892	10007650841
264	224	10007650895	10007650844
296	256	10007650897	10007650847
328	288	10007650900	10007650849
360	320	10007650905	10007650853
392	352	10007650910	10007650857
424	384	10007650915	10007650860
488	448	10007650920	10007650863
600	560	10007650930	10007650865
700	660	10007650940	10007650867
800	760	10007650950	10007650869

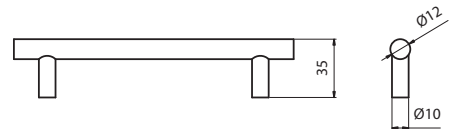

A001 - fém / alumínium

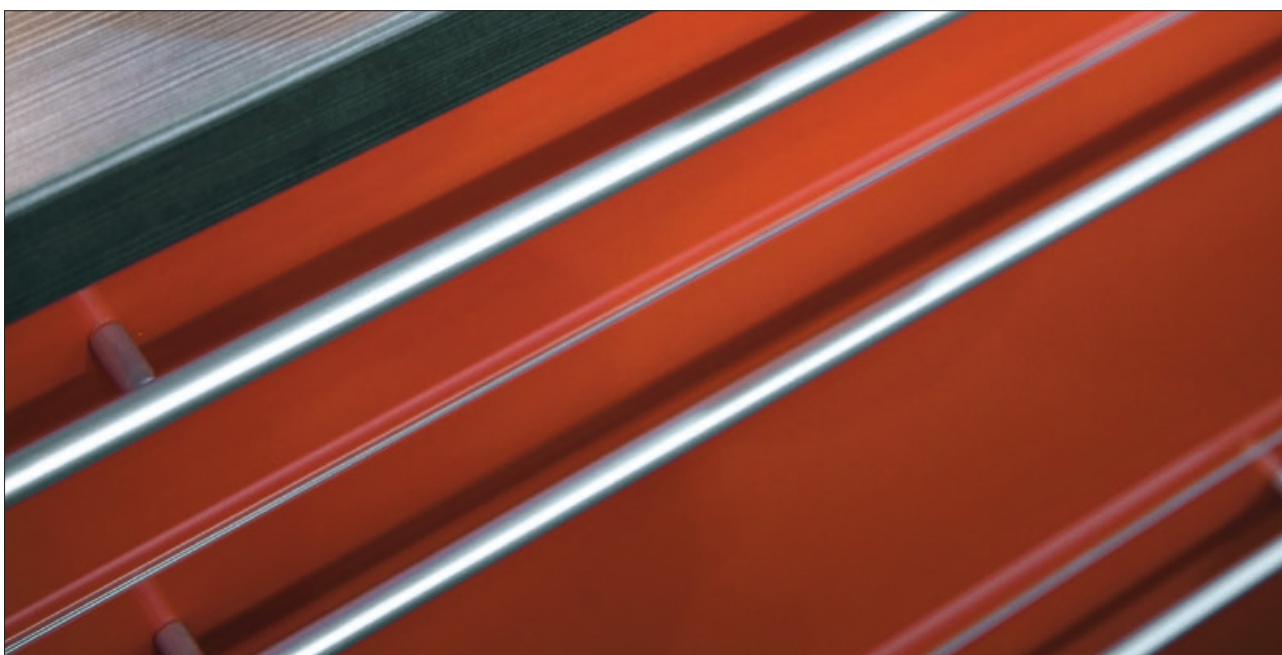
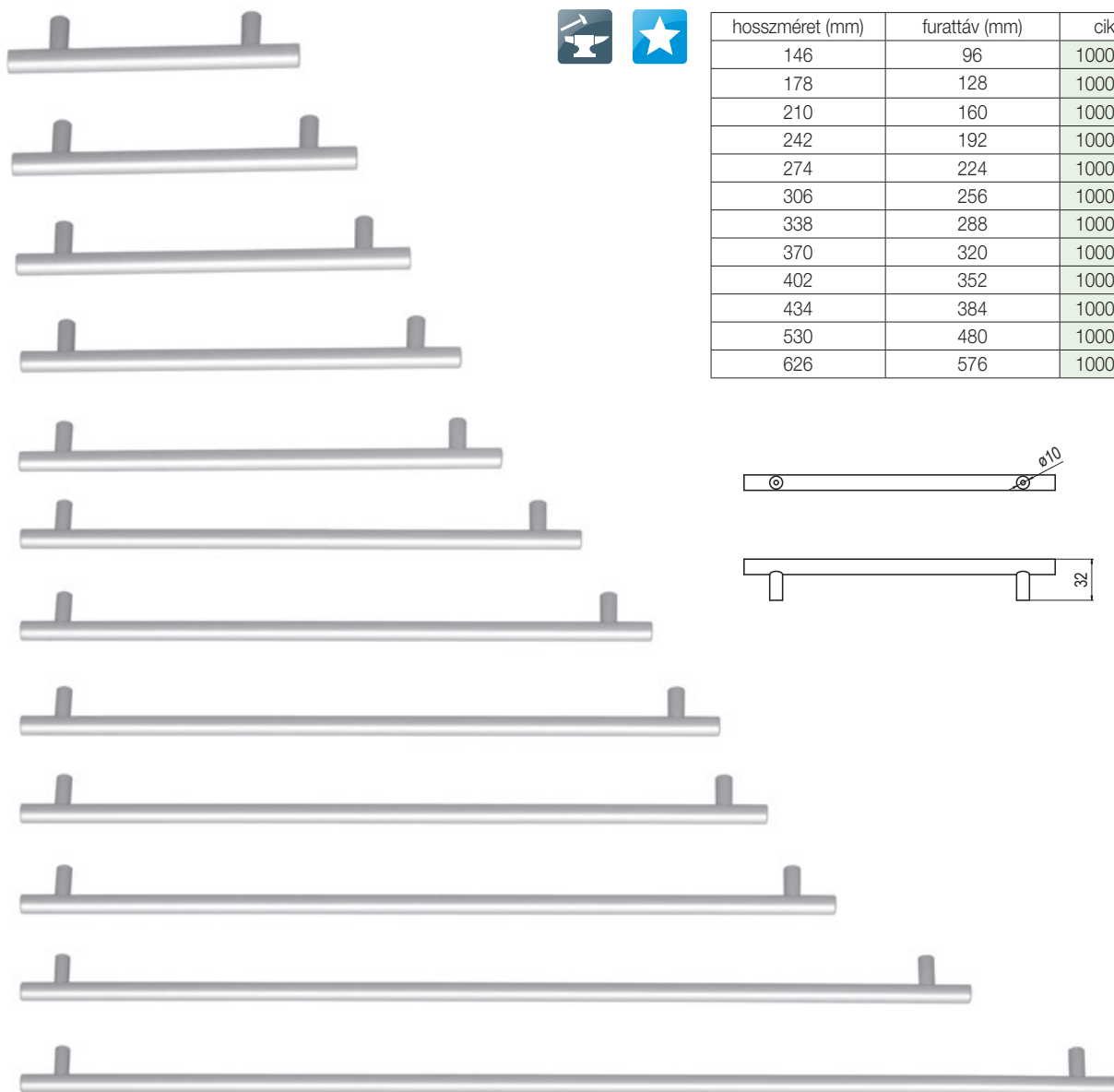

A003 - fém / alumínium



hosszméret (mm)	furattáv (mm)	cikkszám
108	96	10007650110
140	128	10007650120

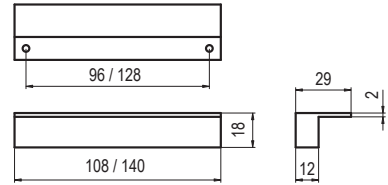

A005 - fém / alumínium



hosszméret (mm)	furattáv (mm)	cikkszám
120	96	10007650150
152	128	10007650160

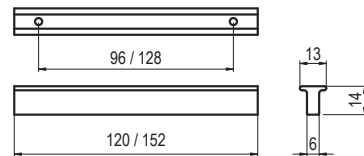

A006 - fém / alumínium



hosszméret (mm)	furattáv (mm)	cikkszám
76	64	10007650170
108	96	10007650180
140	128	10007650190

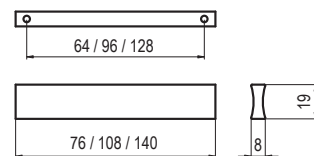

A008 - fém / alumínium



hosszméret (mm)	furattáv (mm)	cikkszám
84	64	10007650230
116	96	10007650240
148	128	10007650250

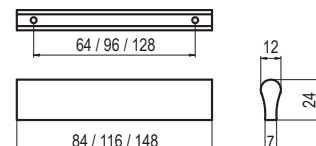

A009 - fém / alumínium



hosszméret (mm)	furattáv (mm)	cikkszám
140	128	10007650260
172	160	10007650270

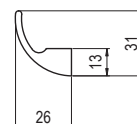
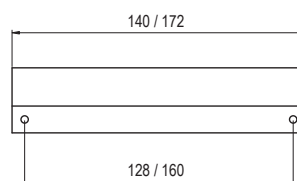

A010-128 - fém / alumínium



hosszméret (mm)	cikkszám
146	10007650290

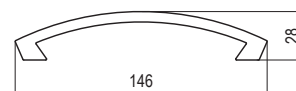
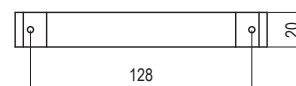

A013-128 - fém / alumínium



hosszméret (mm)	cikkszám
146	10007650320

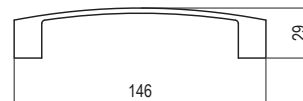
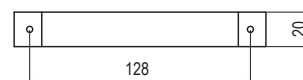

A025 - fém / alumínium



hosszméret (mm)	furattáv (mm)	cikkszám
118	96	10007653330
150	128	10007653340
182	160	10007653350
214	192	10007653360

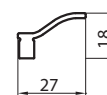
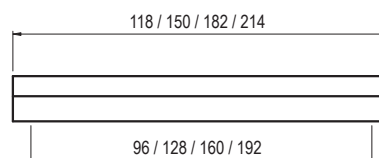

A026 - fém / alumínium



hosszméret (mm)	furattáv (mm)	cikkszám
156	96	10007653370
188	128	10007653380
220	160	10007653390
252	192	10007653400

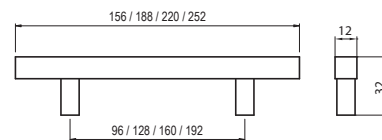

A015 - fém / alumínium



hosszméret (mm)	furattáv (mm)	cikkszám
118	96	10007653030
150	128	10007653040
182	160	10007653050

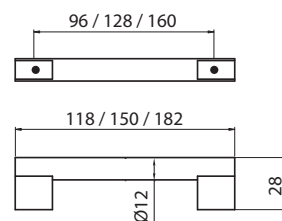

A016 - fém / alumínium

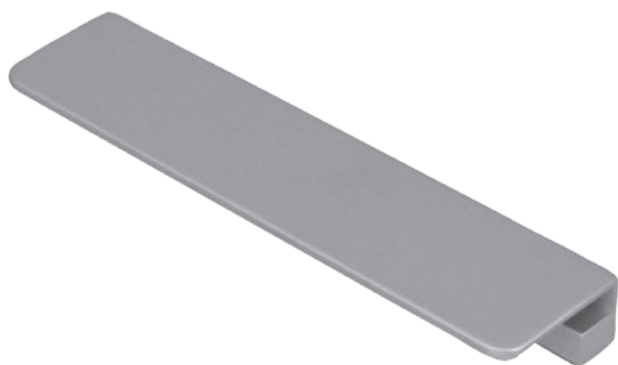

hosszméret (mm)	furattáv (mm)	cikkszám
118	96	10007653060
150	128	10007653070
182	160	10007653080
214	192	10007653090

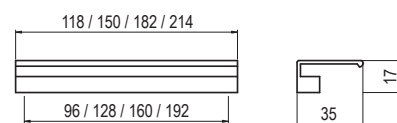

A018 - fém / alumínium

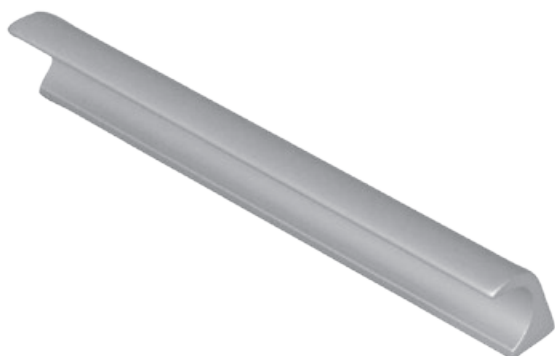

hosszméret (mm)	furattáv (mm)	cikkszám
120	96	10007653130
152	128	10007653140
184	160	10007653150
216	192	10007653160

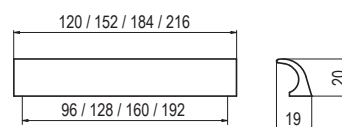

A021 - fém / alumínium



hosszméret (mm)	furattáv (mm)	cikkszám
126	96	10007653200
158	128	10007653210
195	160	10007653220
234	192	10007653230

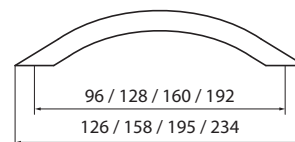

A024 - fém / alumínium

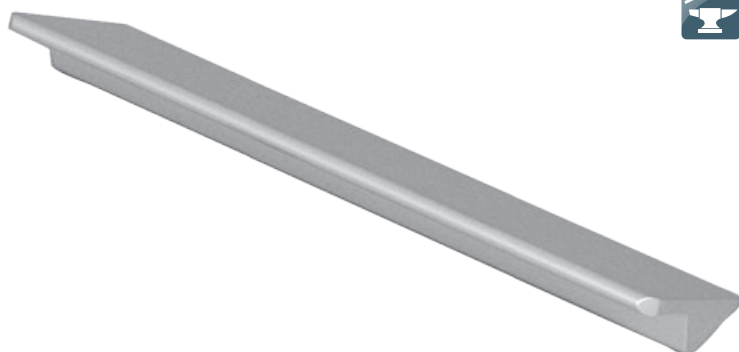

hosszméret (mm)	furattáv (mm)	cikkszám
120	96	10007653290
152	128	10007653300
184	160	10007653310
216	192	10007653320

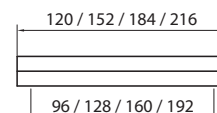

A023 - fém / alumínium



hosszméret (mm)	furattáv (mm)	cikkszám
165	96	10007653260
199	128	10007653270
232	160	10007653280

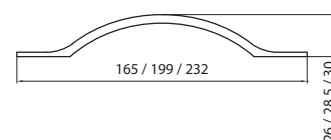
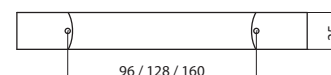

A019-020 - fém / alumínium



méret	cikkszám
D: 20 mm, H: 30 mm	10007653170

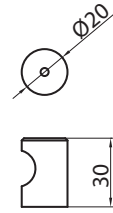

A020-22 - fém / alumínium



méret	cikkszám
D: 10-25 mm, H: 21 mm	10007653180

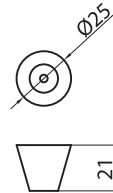

A020-025 - fém / alumínium



méret	cikkszám
D: 18-25 mm, H: 25 mm	10007653190

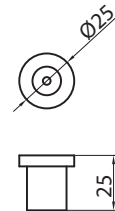

E078-96 / E078-128 - fém / alumínium



E078-96	cikkszám
1. fehér	10007652511
2. fekete	10007652510

E078-128	cikkszám
1. fehér	10007652521
2. fekete	10007652520

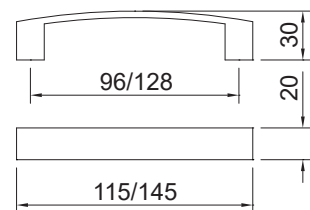

1597-52 - fém

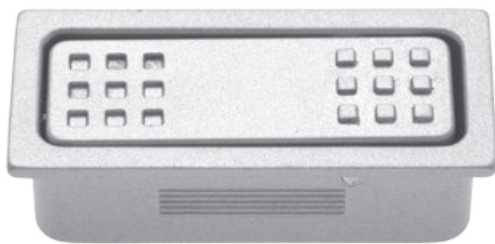

SIRO
www.siro.ccc



szín	cikkszám
aluminium	10007304710

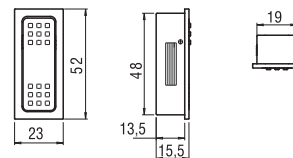

1651-113 - fém



SIRO
www.siro.ccc



szín	cikkszám
aluminium	10007304740

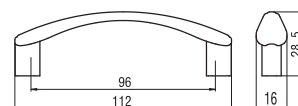

1652-35 - fém



SIRO
www.siro.ccc



szín	cikkszám
aluminium	10007304760

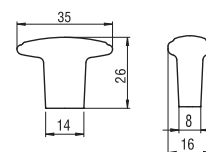

392A / 392B - fém



392A - hossz méret: 329 mm	
1. galvanizált nikkell	10007500830
2. matt króm	10007500832
3. matt nikkell	10007500835

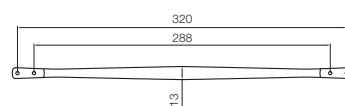

392B - hossz méret: 202 mm	
1. galvanizált nikkell	10007500840
2. matt króm	10007500842
3. matt nikkell	10007500845

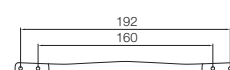

C383A /C383C - fém



C383A	cikkszám
1. galvanizált nikkell	10007500690
2. matt króm	10007500695

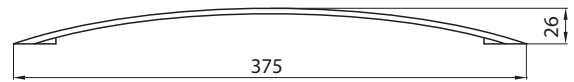
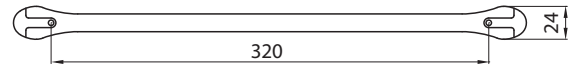

C383C	cikkszám
1. galvanizált nikkell	10007500700
2. matt króm	10007500705

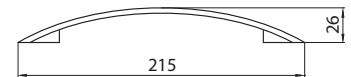
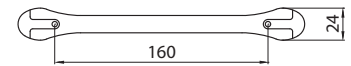

C374B - fém



szín	cikkszám
1. galvanizált nikkell	10007500650
2. matt króm	10007500655

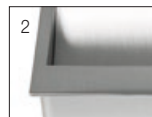
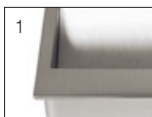
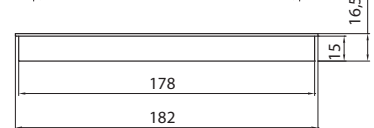
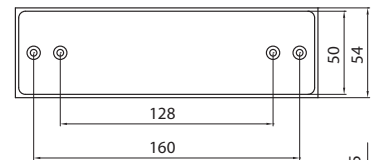

C323 - fém

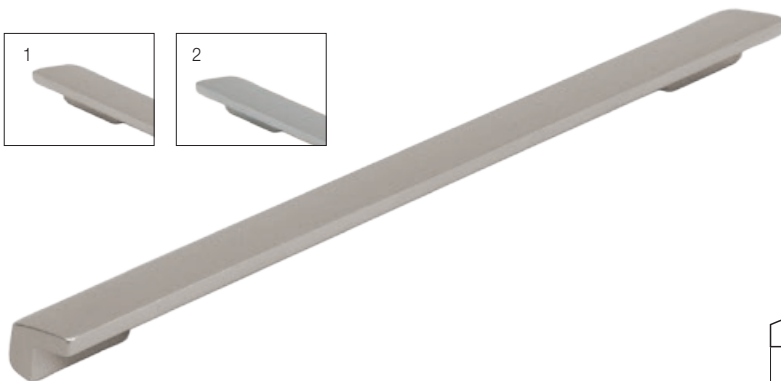
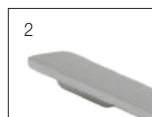

szín	cikkszám
1. galvanizált nikkell	10007500460
2. matt króm	10007500465

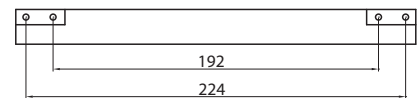

C382C / C382A - fém

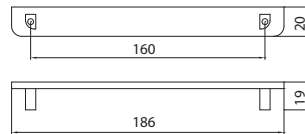
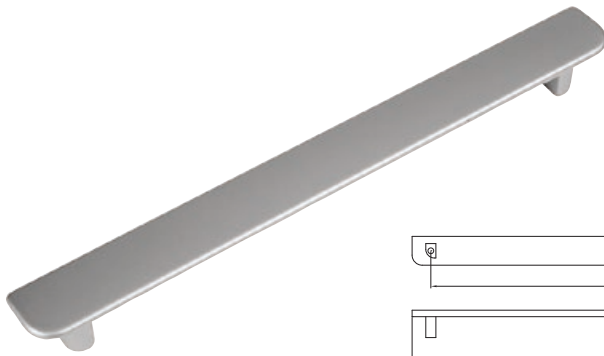

C382C - hossz méret: 186 mm	
1. matt króm	10007500770
2. matt nikkell	10007500772
3. titanium	10007500777

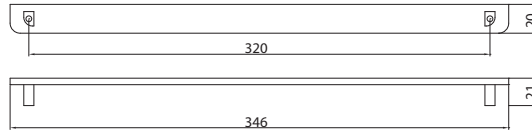

C382A - hossz méret: 346 mm	
1. matt króm	10007500760
2. matt nikkell	10007500762
3. titanium	10007500767



C387C / C387B / C387A - fém

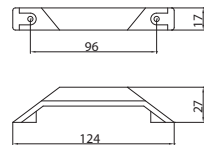

C387C - hossz méret: 124 mm	
1. matt króm	10007500800
2. matt nikkell	10007500802
3. titanium	10007500807

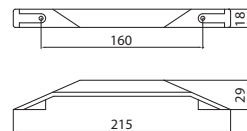

C387B - hossz méret: 215 mm	
1. matt króm	10007500790
2. matt nikkell	10007500792
3. titanium	10007500797

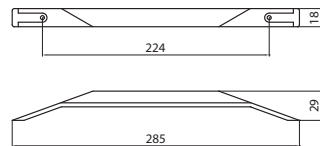

C387A - hossz méret: 285 mm	
1. matt króm	10007500780
2. matt nikkell	10007500782
3. titanium	10007500787

C338B / C338A - fém

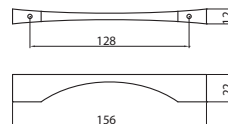

C338B - hossz méret: 156 mm	
1. galvanizált nikkell	10007500480
2. matt króm	10007500485

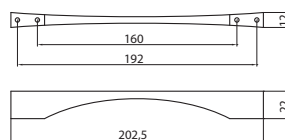

C338A - hossz méret: 202,5 mm	
1. galvanizált nikkell	10007500470
2. matt króm	10007500475

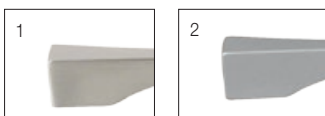

C366C / C366B - fém

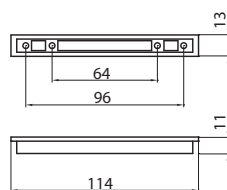
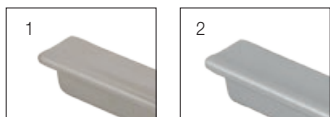

C366C - hossz méret: 114 mm

1. galvanizált nikkell	10007500570
2. matt króm	10007500575

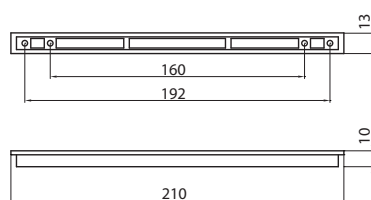

C366B - hossz méret: 209,5 mm

1. galvanizált nikkell	10007500560
2. matt króm	10007500565

C360C / C360B / C360A - fém

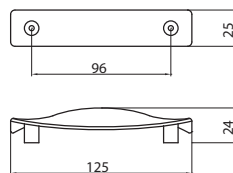
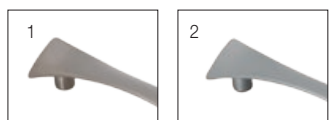

C360C - hossz méret: 125 mm

1. galvanizált nikkell	10007500540
2. matt króm	10007500545

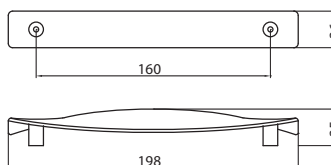

C360B - hossz méret: 198 mm

1. galvanizált nikkell	10007500530
2. matt króm	10007500535

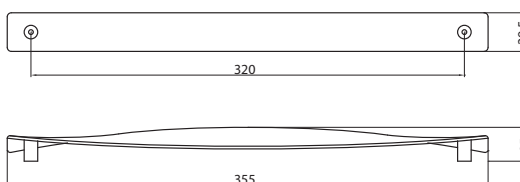

C360A - hossz méret: 355 mm

1. galvanizált nikkell	10007500520
2. matt króm	10007500525

C388C / C388B - fém

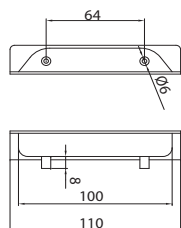
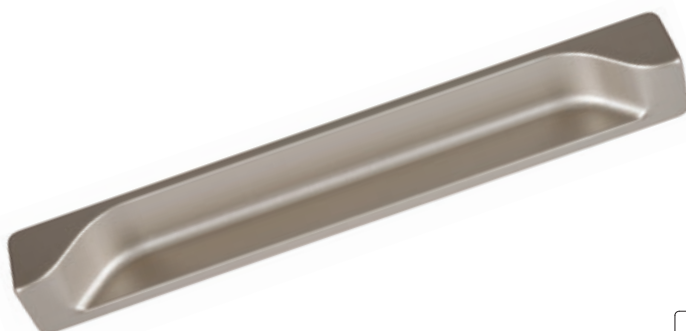

C388C - hossz méret: 110 mm

1. matt króm	10007500820
2. matt nikkell	10007500822
3. titanium	10007500827

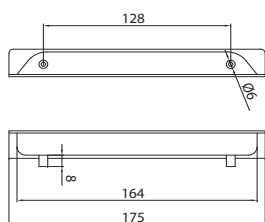

C388B - hossz méret: 175 mm

1. matt króm	10007500810
2. matt nikkell	10007500812
3. titanium	10007500817

C363C / C363B - fém



C363C - hosszúság: 70 mm

matt króm 10007500555

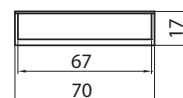
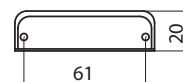

C363B - hosszúság: 168 mm

matt króm 10007500550

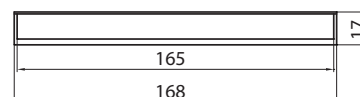
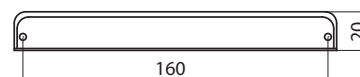

C374C - fém



szín cikkszám

1. galvanizált nikkell 10007500620

2. matt króm 10007500625

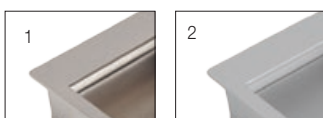
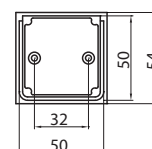

C2033 - fém



szín cikkszám

1. galvanizált nikkell 10007500285

2. matt króm 10007500280

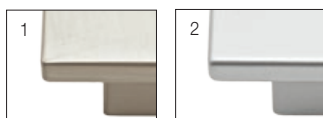
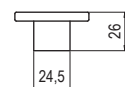
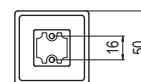

C341 - fém



szín cikkszám

1. galvanizált nikkell 10007500385

2. matt króm 10007500380

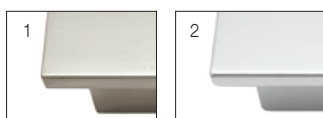
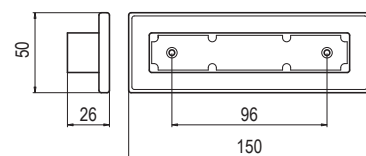

C348B / C348A - fém



C348B - hossz méret: 144 mm	
1. matt króm	10007500340

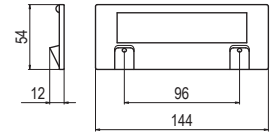

C348A - hossz méret: 208 mm	
matt króm	10007500330

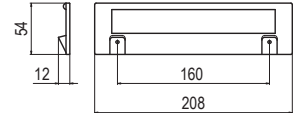

C336 - fém



szín	cikkszám
1. matt króm	10007500300
2. galvanizált nikkell	10007500305

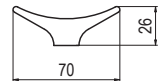
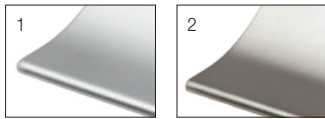
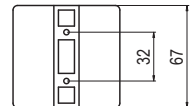

C352A / C352B - fém



C352A - méret: 80x80 mm	
1. matt króm	10007500350
2. galvanizált nikkell	10007500355

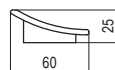
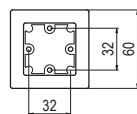
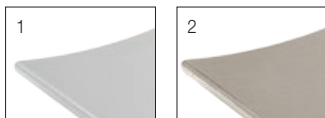
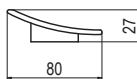
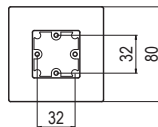

C352B - méret: 60x60 mm	
1. matt króm	10007500360
2. galvanizált nikkell	10007500365

397B - fém



szín	cikkszám
1. galvanizált nikkell	10007500850
2. matt króm	10007500852
3. matt nikkell	10007500855

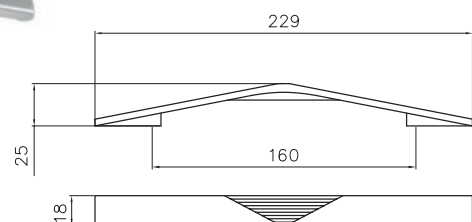
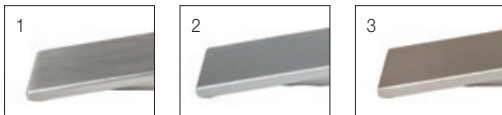

C330 - fém



szín	cikkszám
1. matt króm	10007500270
2. galvanizált nikkel	10007500275

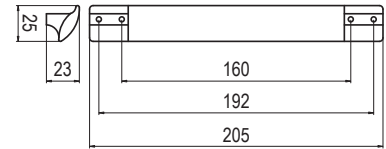
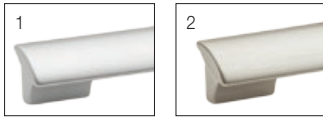

C344 - fém



szín	cikkszám
1. matt króm	10007500370
2. galvanizált nikkel	10007500375

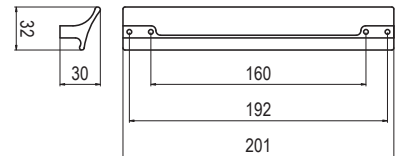
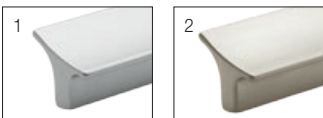

C347A / C347B - fém

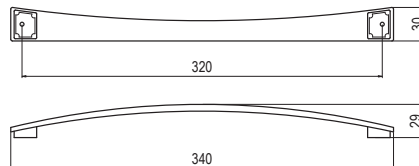

C347A - hossz méret: 340 mm	
1. matt króm	10007500250
2. galvanizált nikkel	10007500255
3. titanium	10007500257

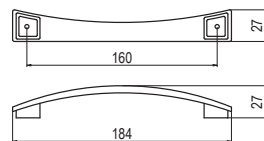

C347B - hossz méret: 184 mm	
1. matt króm	10007500260
2. galvanizált nikkel	10007500265
3. titanium	10007500267

C332A / C332B - fém

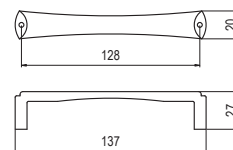

C332B - hossz méret: 137 mm	
1. matt króm	10007500320
2. galvanizált nikkel	10007500325

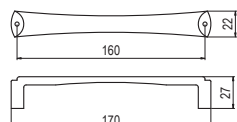
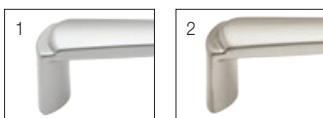

C332A - hossz méret: 170 mm	
1. matt króm	10007500310
2. galvanizált nikkel	10007500315

C310 - fém



szín	cikkszám
1. matt króm	10007500150
2. matt nikkel	10007500152
3. galvanizált nikkel	10007500155

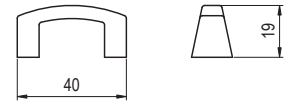
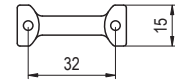

C293 - fém



szín	cikkszám
1. matt króm	10007500030
2. matt nikkel	10007500032
3. galvanizált nikkel	10007500035

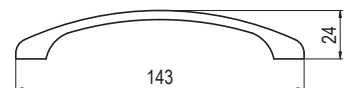
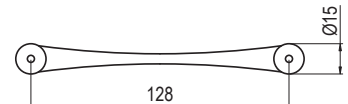

C315C / C315B / C315A - fém

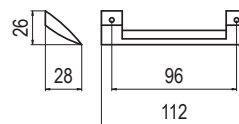

C315C - hossz méret: 112 mm	
1. matt króm	10007500180
2. matt nikkel	10007500182
3. galvanizált nikkel	10007500185

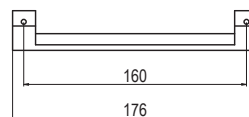

C315B - hossz méret: 175 mm	
1. matt króm	10007500170
2. matt nikkel	10007500172
3. galvanizált nikkel	10007500175

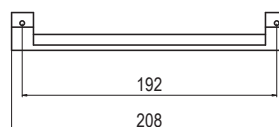

C315A - hossz méret: 208 mm	
1. matt króm	10007500160
2. matt nikkel	10007500162
3. galvanizált nikkel	10007500165

C316 / C317 - fém

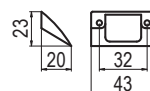
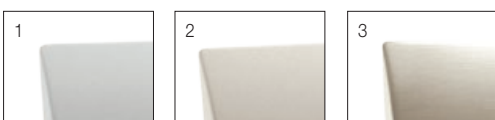

C317 - hossz méret: 43 mm	
1. matt króm	10007500200
2. matt nikkel	10007500202
3. galvanizált nikkel	10007500205

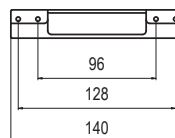

C316 - hossz méret: 140 mm	
1. matt króm	10007500190
2. matt nikkel	10007500192
3. galvanizált nikkel	10007500195

C307 - fém



szín	cikkszám
1. matt króm	10007500130
2. matt nikkel	10007500132
3. titanium	10007500137

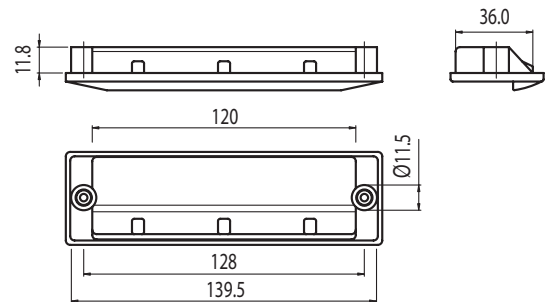

Bemarási méret: 139,5 x 36 x 12 mm

C303A / C303B / C303C - fém

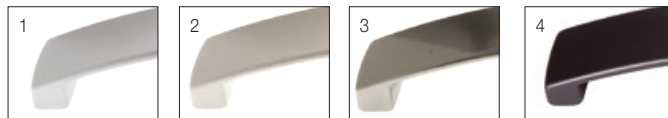

C303A - hossz méret: 205 mm	
1. matt króm	10007500080
2. matt nikkel	10007500082
3. galvanizált nikkel	10007500085
4. titanium	10007500087

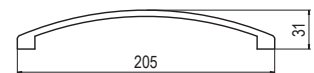
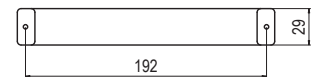

C303B - hossz méret: 171 mm	
1. matt króm	10007500090
2. matt nikkel	10007500092
3. galvanizált nikkel	10007500095
4. titanium	10007500097

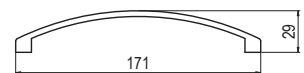
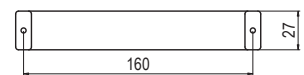

C303C - hossz méret: 138 mm	
1. matt króm	10007500100
2. matt nikkel	10007500102
3. galvanizált nikkel	10007500105
4. titanium	10007500107

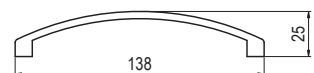
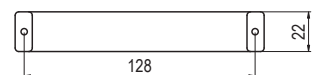

C335 - fém



szín	cikkszám
1. matt króm	10007500210
2. matt nikkel	10007500212
3. galvanizált nikkel	10007500215

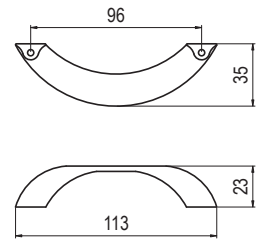

C265 - fém



szín	cikkszám
1. matt króm	10007500000
2. matt nikkel	10007500002
3. galvanizált nikkel	10007500005

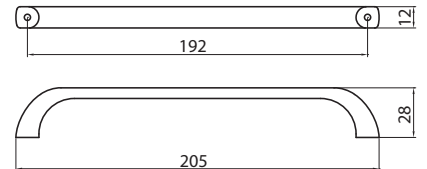

C305 - fém



szín	cikkszám
1. matt króm	10007500110
2. matt nikkel	10007500112
3. galvanizált nikkel	10007500115

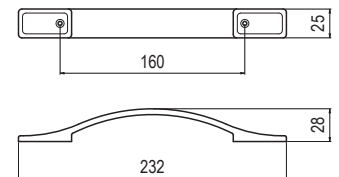

C306 - fém



szín	cikkszám
matt króm	10007500120

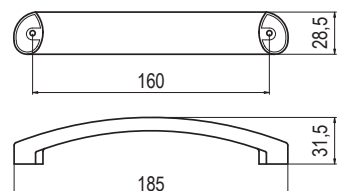

MB09107B0 - fém Design: Massimo Cavana

CONFAÖNIERI

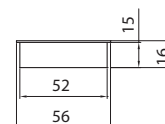
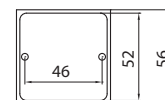

szín	cikkszám
patagónia ezüst	10007590050

MB091020 - fém Design: Massimo Cavana

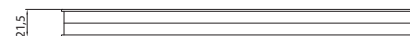
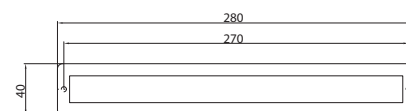
szín	cikkszám
1. pretória króm	10007590110
2. botswana nikkel	10007590111

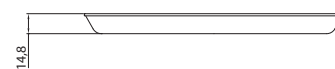
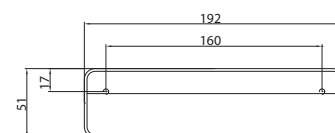

MB091480 - fém Design: Fabio Casiraghi - Studio Nava

szín	cikkszám
1. patagónia ezüst	10007590150
2. matt fehér	10007590151

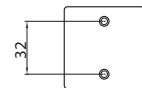
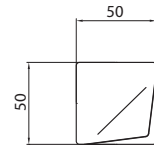

MB091420 - fém Design: Fabio Casiraghi - Studio Nava**CONFAÖNIERI**

szín	cikkszám
1. patagónia ezüst	10007590120
2. caledonia nikkell	10007590121
3. matt fehér	10007590122

**MB091430** - fém Design: Fabio Casiraghi - Studio Nava

szín	cikkszám
1. patagónia ezüst	10007590130
2. caledonia nikkell	10007590131
3. matt fehér	10007590132

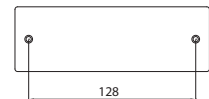
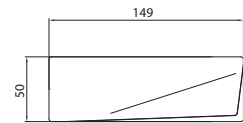
**MB091440** - fém Design: Fabio Casiraghi - Studio Nava

szín	cikkszám
1. patagónia ezüst	10007590140
2. caledonia nikkell	10007590141
3. matt fehér	10007590142

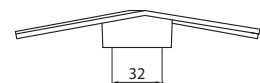
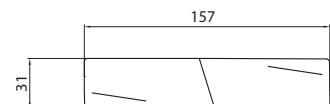

MB09045A0 - fém Design: Franco Guanzioli

CONFAIÖNERI 



szín	cikkszám
patagónia ezüst	10007590070

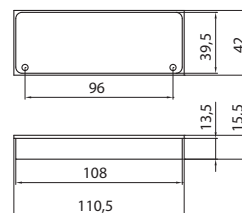

MB09045A0 - fém Design: Massimo Cavana



szín	cikkszám
patagónia ezüst	10007590040

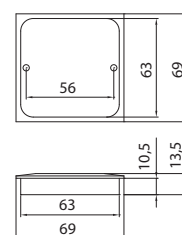

MB09132B0 - fém

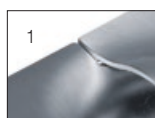
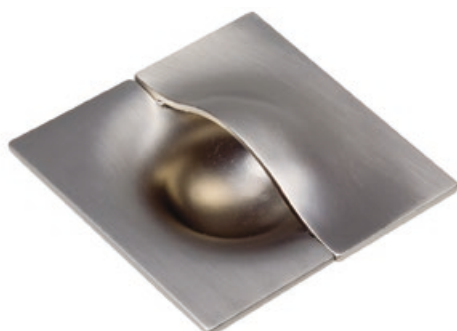

szín	cikkszám
1. patagónia ezüst	10007590080
2. caledonia nikkél	10007590081

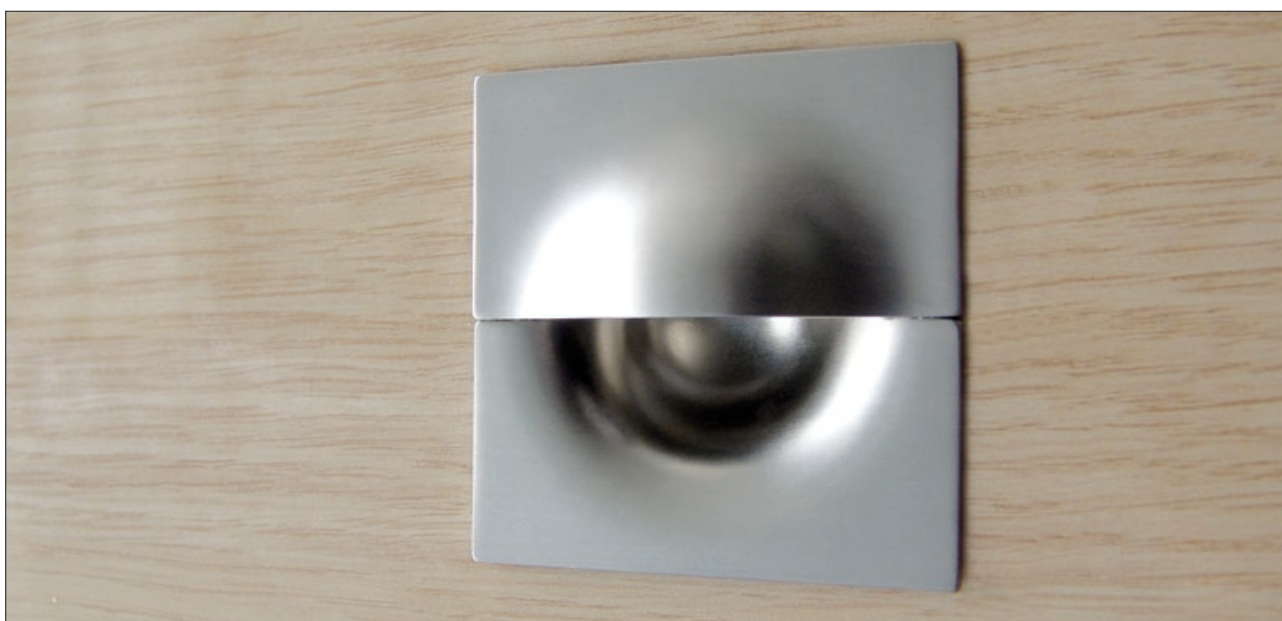
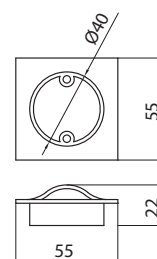

2381-188 / 2381-348 - fém



2381-188	cikkszám
1. króm	10007306990
2. fekete nikkell	10007306991
3. nikkell	10007306992
4. matt antracit	10007306993

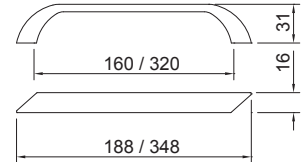

2381-348	cikkszám
1. króm	10007307000
2. fekete nikkell	10007307001
3. nikkell	10007307002
4. matt antracit	10007307003

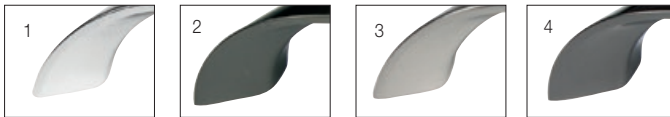

2392-192 / 2392-352 - fém



2392-192	cikkszám
1. króm	10007307010
2. fekete nikkell	10007307011
3. nikkell	10007307012

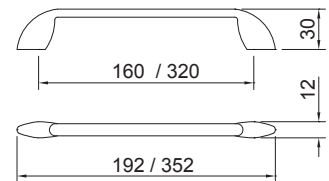

2392-352	cikkszám
1. króm	10007307020
2. fekete nikkell	10007307021
3. nikkell	10007307022



2411-58 - fém



szín	cikkszám
1. fekete nikkell	10007307030
2. nikkell	10007307031
3. fekete réz	10007307032

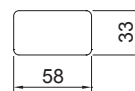

2413-175 / 2413-335 - fém



2413-175	cikkszám
1. króm	10007307040
2. fekete nikkell	10007307041
3. nikkell	10007307042

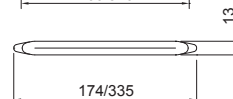
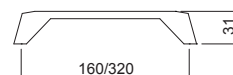

2413-335	cikkszám
1. króm	10007307050
2. fekete nikkell	10007307051
3. nikkell	10007307052

2414-188 / 2414-348 - fém

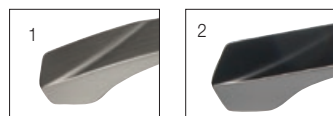

2414-188	cikkszám
1. acél	10007307060
2. matt antracit	10007307061

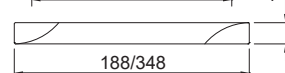
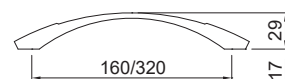

2414-348	cikkszám
1. acél	10007307070
2. matt antracit	10007307071

2415-192 / 2413-352 - fém

SIRO®
www.siro.cc

2415-192	cikkszám
1. króm	10007307080
2. fekete nikkell	10007307081
3. nikkell	10007307082

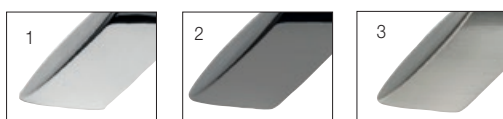
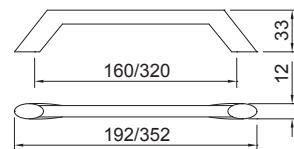

2415-352	cikkszám
1. króm	10007307090
2. fekete nikkell	10007307091
3. nikkell	10007307092



2341-173 / 2341-345 - fém



szín	hosszméret (mm)	furattáv (mm)	cikkszám
1. króm	173	160	10007306810
	345	320	10007306820
2. fekete nikkell	173	160	10007306811
	345	320	10007306821
3. acél	173	160	10007306812
	345	320	10007306822

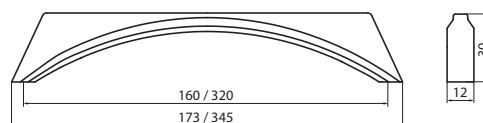

2338-64 - fém



szín	cikkszám
1. króm	10007306830
2. fekete nikkell	10007306831
3. acél	10007306832
4. vörösréz	10007306833

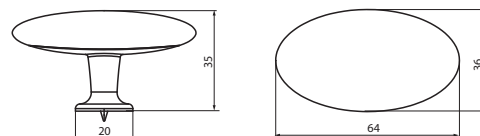

2318-200 / 2318-360 - fém



szín	hosszméret (mm)	furattáv (mm)	cikkszám
1. króm	200	160	10007306840
	360	320	10007306850
2. nikkell	200	160	10007306841
	360	320	10007306851
3. vörösréz	200	160	10007306842
	360	320	10007306852

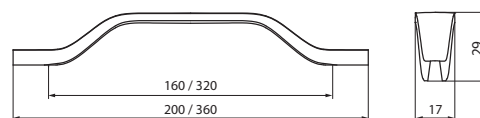

2311-200 / 2311-360 - fém



hosszméret: 200 mm		cikkszám
1. króm		10007306860
2. nikkell		10007306861
3. alumínium		10007306862

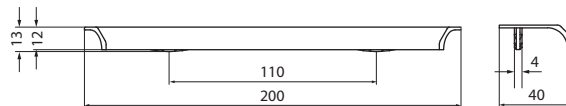

hosszméret: 360 mm		cikkszám
1. króm		10007306870
2. nikkell		10007306871
3. alumínium		10007306872

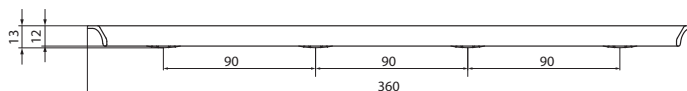

Bemartható fogantyú. A rögzítést fém „lapostipli” fűlek segítik.

2266-177 / 2266-337 - fém



szín	hosszméret (mm)	furattáv (mm)	cikkszám
1. króm	177	160	10007306880
	377	320	10007306890
2. nikkell	177	160	10007306881
	377	320	10007306891
3. fekete nikkell	177	160	10007306882
	377	320	10007306892

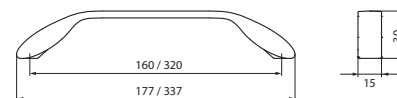

2197-214 - fém



szín	cikkszám
1. króm	10007306900
2. nikkell	10007306901
3. szálcsiszolt acél	10007306902

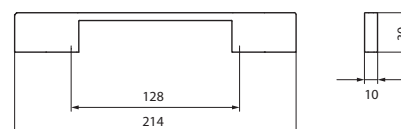

2027-204 - fém



szín	cikkszám
1. króm	10007306910
2. nikkell	10007306911
3. szálcsiszolt acél	10007306912

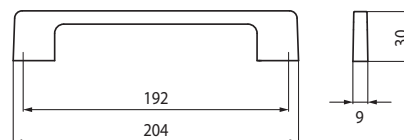

2374-180 / 2374-340 - fém



szín	hossz. (mm)	furattáv (mm)	cikkszám
1. króm	180	160	10007306920
	340	320	10007306930
2. acél	180	160	10007306921
	340	320	10007306931
3. fekete nikkell	180	160	10007306922
	340	320	10007306932
4. szálcsiszolt acél	180	160	10007306923
	340	320	10007306933

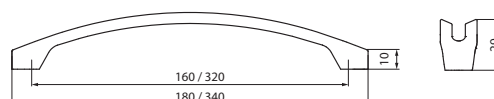
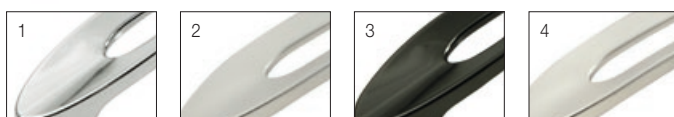

2356-185 / 2356-339 - fém



szín	hosszméret (mm)	furattáv (mm)	cikkszám
1. króm	185	160	10007306940
	339	320	10007306950
2. fekete nikkell	185	160	10007306941
	339	320	10007306951
3. acél	185	160	10007306942
	339	320	10007306952
4. matt antracit	185	160	10007306943
	339	320	10007306953

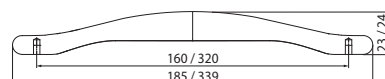
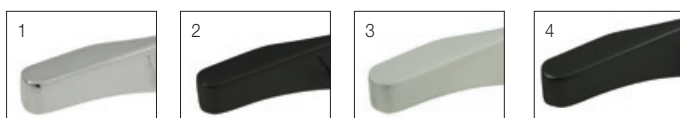

1746-35 - fém

SIRO[®]
www.siro.cc

szín	cikkszám
1. króm	10007306960
2. nikkell	10007306961
3. vörösréz	10007306962

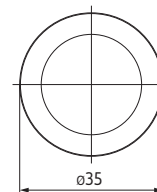
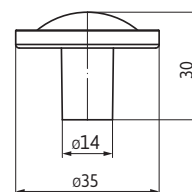

2343-183 / 2343-343 - fém



szín	hosszméret (mm)	furattáv (mm)	cikkszám
1. króm	182	160	10007306970
	343	320	10007306971
2. acél	182	160	10007306980
	343	320	10007306981

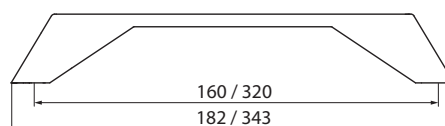

2184-137 / 2184-200 - fém



szín	hosszméret (mm)	furattáv (mm)	cikkszám
1. króm-fekete	137	96	10007306790
	200	160	10007306800
2. nikkelfehér	137	96	10007306791
	200	160	10007306801

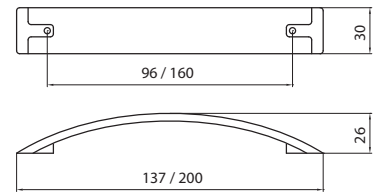
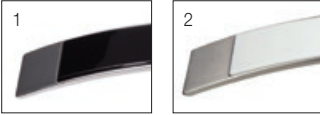

2113-137 / 2113-168 - fém



hosszméret: 137 mm	cikkszám
1. króm	10007306700
2. nikkelfehér	10007306701

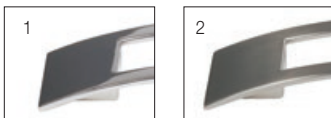
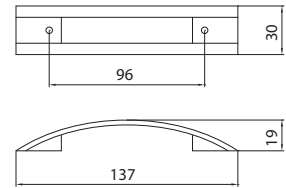

hosszméret: 168 mm	cikkszám
1. króm	10007305150

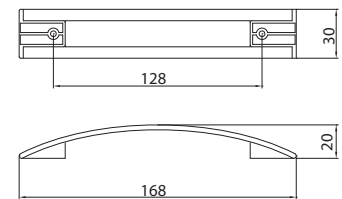

2198-173 / 2198-333 - fém



szín	hosszméret (mm)	furattáv (mm)	cikkszám
1. króm	173	160	10007306770
	333	320	10007306780
2. nikkelfehér	173	160	10007306771
	333	320	10007306781

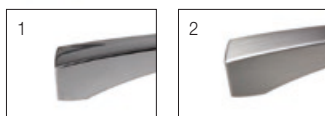
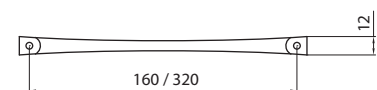

2110 - fém

SIRO[®]
www.siro.cc

szín	hosszméret (mm)	furattáv (mm)	cikkszám
króm	252	128 / 224	10007306710
	284	160 / 256	10007306720
	348	224 / 320	10007306730

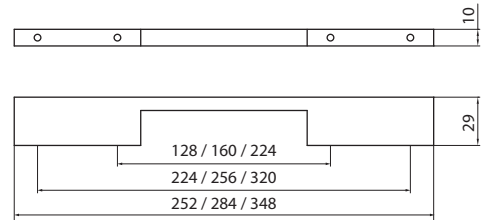

2182 - fém



szín	hosszméret (mm)	furattáv (mm)	cikkszám
1. króm	118	96	10007306640
	182	160	10007306650
	342	320	10007306660
2. nikkell	118	96	10007306641
	182	160	10007306651
	342	320	10007306661

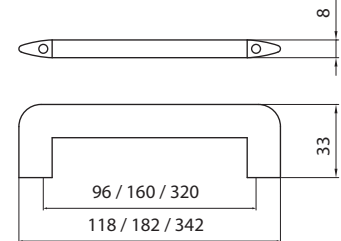

2183 - fém



szín	hosszméret (mm)	furattáv (mm)	cikkszám
1. króm	104	96	10007306670
	168	160	10007306680
	328	320	10007306690
2. nikkell	104	96	10007306671
	168	160	10007306681
	328	320	10007306691

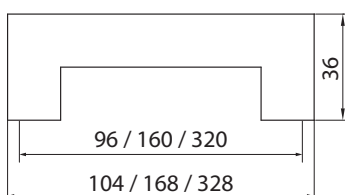
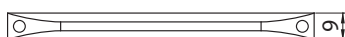

2057-75 - fém

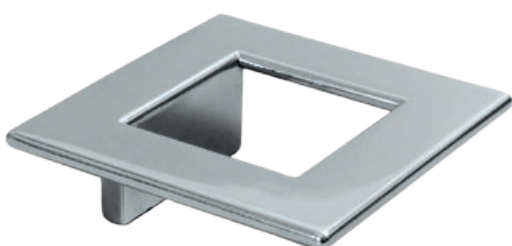

szín	cikkszám
króm	10007305170

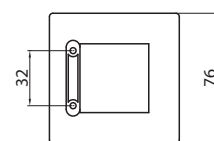

2108-168 - fém



szín	cikkszám
nikkell	10007305180

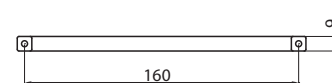

2035-72 - fém

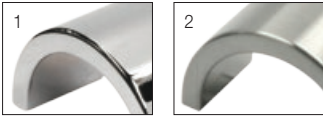

szín	cikkszám
1. króm	10007306600
2. nikkel	10007306601

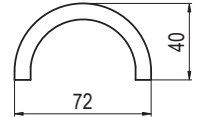
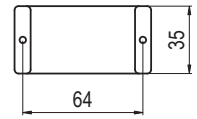

2035-232 - fém

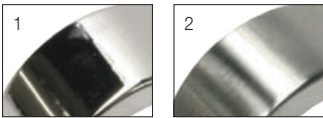
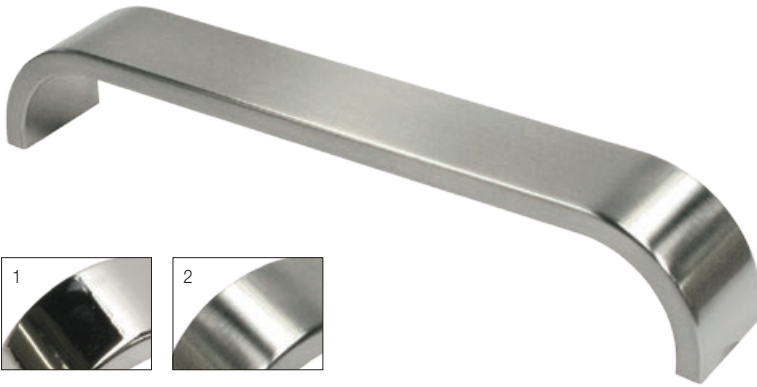

szín	cikkszám
1. króm	10007306610
2. nikkel	10007306611

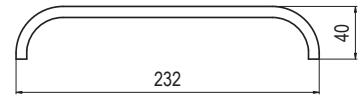
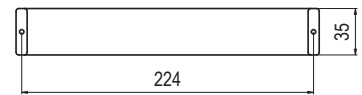

2092-65 - fém

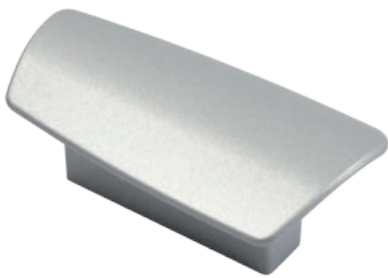

szín	cikkszám
aluminium	10007306620

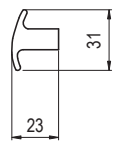
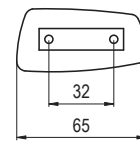

2120-136 - fém



szín	cikkszám
króm	10007305190

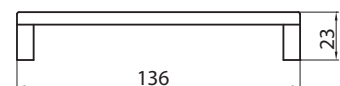
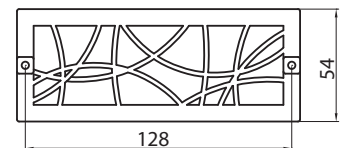

2040-20 - fém



szín	cikkszám
1. nikkell	10007305080
2. alumínium	10007305081

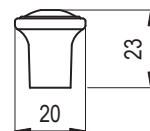
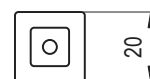

2038-110 / 2038-142 - fém



szín	hosszméret (mm)	furattáv (mm)	cikkszám
1. nikkell	110	96	10007305090
	142	128	10007305100
2. alumínium	110	96	10007305091
	142	128	10007305101

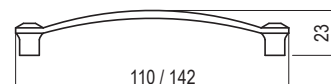
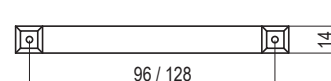

1809-110 - fém



szín	cikkszám
1. nikkell	10007304910
2. króm	10007304911

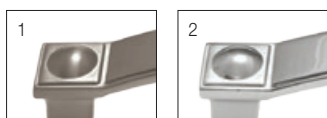
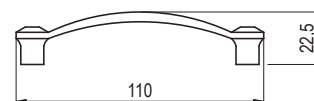
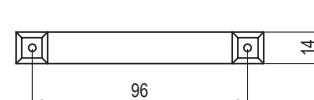

580-224 - fém



szín	cikkszám
1. fényes elefántcsont	10007552370
2. ezüst	10007552371
3. króm	10007552372

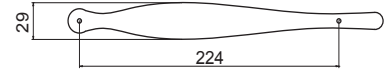

0006-192 - fém

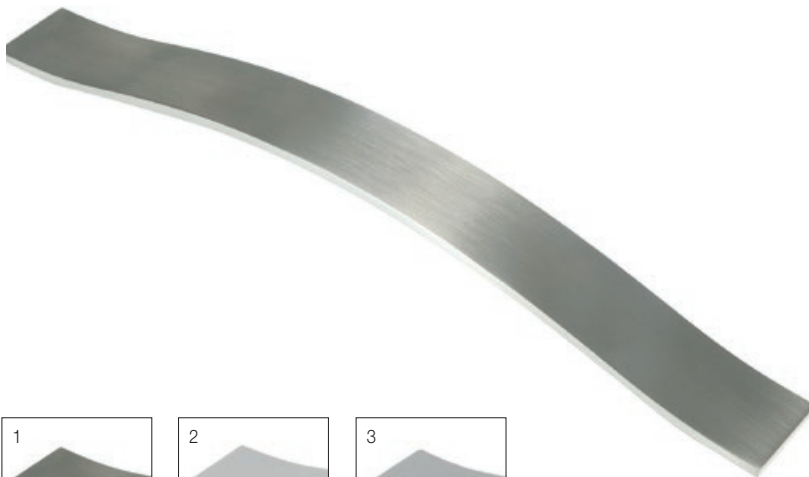

szín	cikkszám
1. nikkell	10007552380
2. króm	10007552381
3. matt alumínium	10007552382

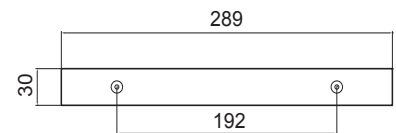

187 - fém

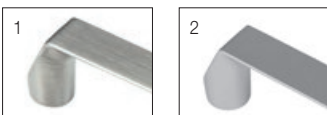
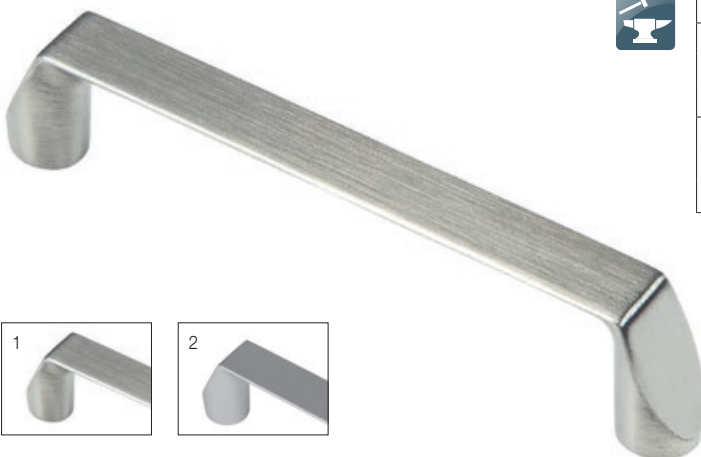

szín	hosszméret (mm)	furattáv (mm)	cikkszám
1. nikkell	107	96	10007552390
	171	160	10007552400
	235	224	10007552410
2. matt alumínium	107	96	10007552391
	171	160	10007552401
	235	224	10007552411

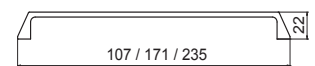
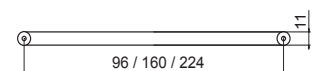

126-64 / 126-128 - fém



szín	méret	cikkszám
1. matt alumínium	128	10007550040
2. nikkell	128	10007550041
3. platina nikkell	64	10007552610
	128	10007552620

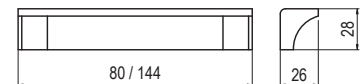
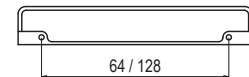

138-192 - fém



szín	cikkszám
1. matt alumínium	10007550100
2. nikkell	10007550101

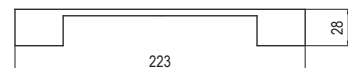
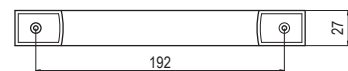

169 - fém

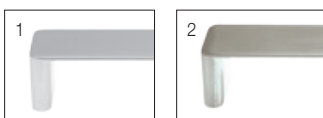

169-128	cikkszám
1. matt alumínium	10007550190
2. nikkell	10007550191

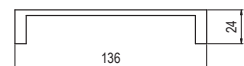
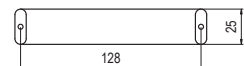

169-160	cikkszám
1. matt alumínium	10007550180
2. nikkell	10007550181

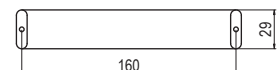

180-128 - fém

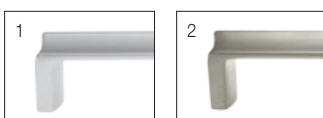

szín	cikkszám
1. matt alumínium	10007550200
2. nikkell	10007550201

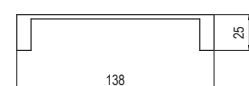
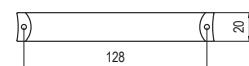

WMN787 - fém



szín	hosszméret (mm)	furattáv (mm)	cikkszám
1. matt platina	110	96	10007552950
	142	128	10007552940
	174	160	10007552930
	206	192	10007552920
	334	320	10007552910
2. antik ón	110	96	10007552951
	142	128	10007552941
	174	160	10007552931
	206	192	10007552921
	334	320	10007552911
3. antik fekete	110	96	10007552952
	142	128	10007552942
	174	160	10007552932
	206	192	10007552922
	334	320	10007552912

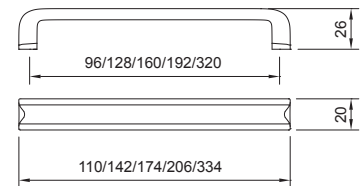

WMN772 - fém



szín	hosszméret (mm)	furattáv (mm)	cikkszám
1. matt platina	110	96	10007552770
	142	128	10007552760
	173	160	10007552750
	206	192	10007552740
	334	320	10007552730
2. antik ón	110	96	10007552771
	142	128	10007552761
	173	160	10007552751
	206	192	10007552741
	334	320	10007552731
3. antik fekete	110	96	10007552772
	142	128	10007552762
	173	160	10007552752
	206	192	10007552742
	334	320	10007552732

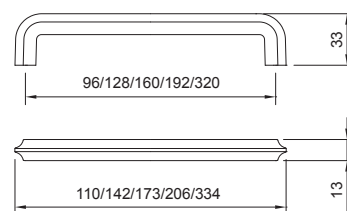

154-160 - fém



szín	cikkszám
1. matt alumínium	10007550150
2. nikkell	10007550151

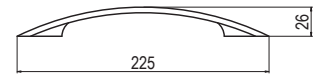
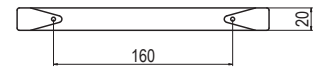
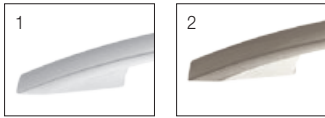

300.032 - fém



szín	cikkszám
1. matt alumínium	10007551180
2. króm	10007551181
3. nikkell	10007551182

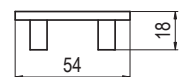
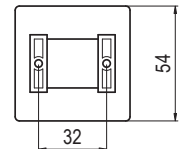
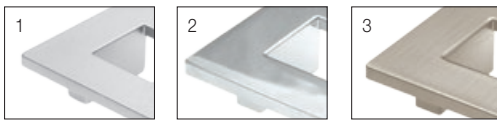

005-B32 - fém



szín	cikkszám
1. matt alumínium	10007551170
2. nikkell	10007551171

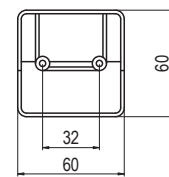
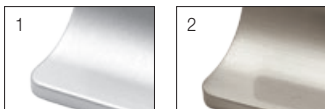

102-128 - fém



szín	cikkszám
1. matt alumínium	10007550000
2. nikkell	10007550001

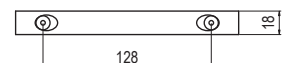
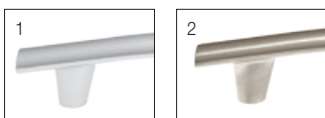

145-160 - fém

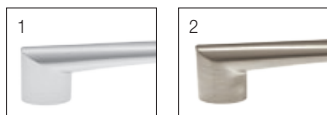

szín	cikkszám
1. matt alumínium	10007550120
2. nikkel	10007550121

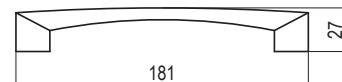
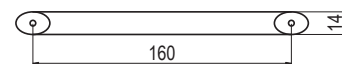

106-160 - fém

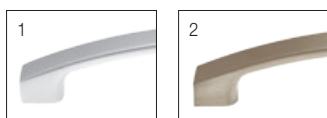

szín	cikkszám
1. matt alumínium	10007550010
2. nikkel	10007550011

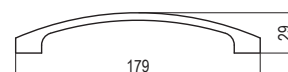
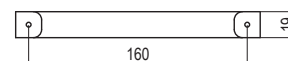

153 - fém

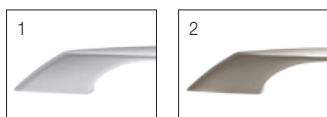

153-128	cikkszám
1. matt alumínium	10007550140
2. nikkel	10007550141

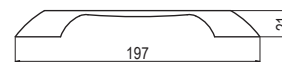
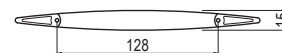

153-160	cikkszám
1. matt alumínium	10007550130
2. nikkel	10007550131

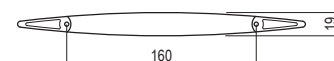

541-064 - fém

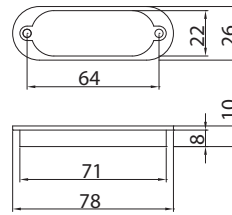

szín	cikkszám
nikkel	10007551710



543-064 - fém

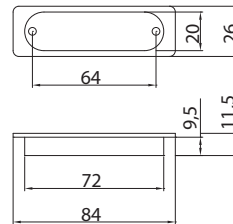

szín	cikkszám
nikkel	10007551720



124.128 - fém

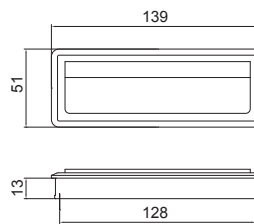
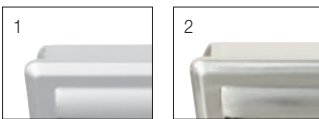

szín	cikkszám
1. matt alumínium	10007552570
2. nikkel	10007552571



552.128 - fém

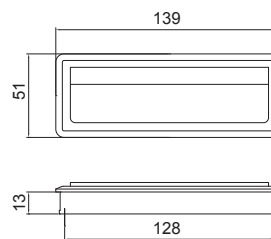

szín	cikkszám
1. platina nikkel	10007552630
2. platina arany	10007552640



317 - fém

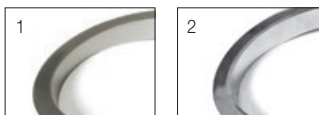
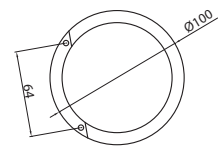
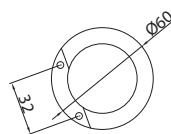

317.032	cikkszám
1. nikkel	10007551740
2. króm	10007551741

317.064	cikkszám
1. nikkel	10007551730
2. króm	10007551731

132 - fém

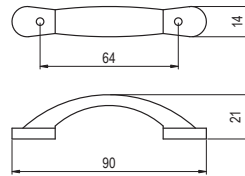

132-64	cikkszám
1. matt alumínium	10007550080
2. króm	10007550081
3. nikkel	10007550082
4. antikolt bronz	10007550083

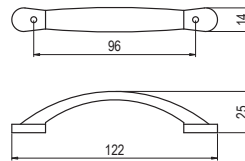

132-96	cikkszám
1. matt alumínium	10007550070
2. króm	10007550071
3. nikkel	10007550072
4. antikolt bronz	10007550073

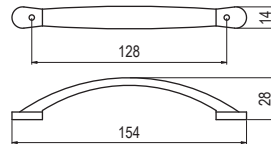

132-128	cikkszám
1. matt alumínium	10007550060
2. króm	10007550061
3. nikkel	10007550062
4. antikolt bronz	10007550063

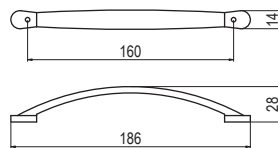

132-160	cikkszám
1. matt alumínium	10007550050
2. króm	10007550051
3. nikkel	10007550052
4. antikolt bronz	10007550053

E058-042 - fém



szín	cikkszám
1. króm	10007652140
2. inox	10007652141

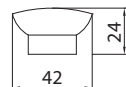
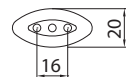

E057-160 - fém

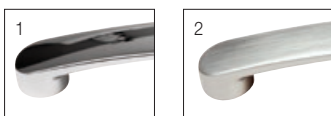

szín	cikkszám
1. króm	10007652130
2. inox	10007652131

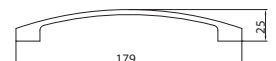
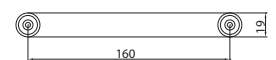

E056-160 - fém



szín	cikkszám
1. króm	10007652120
2. inox	10007652121

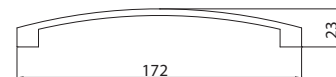
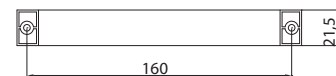

E054-192 - fém



szín	cikkszám
1. inox	10007652100
2. nikkell	10007652101
3. króm	10007652102
4. koptatott bronz	10007652103

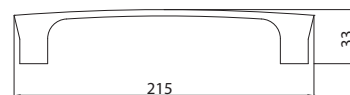
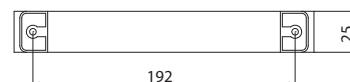

E055-034 - fém



szín	cikkszám
1. inox	10007652110
2. nikkell	10007652111
3. króm	10007652112
4. koptatott bronz	10007652113

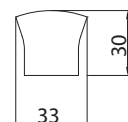
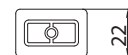

E083-160 / E083-192 - fém

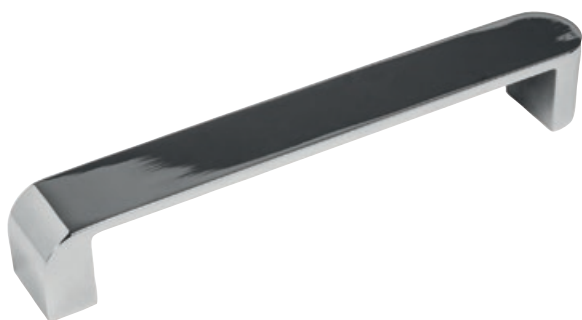

szín	hosszméret (mm)	furattáv (mm)	cikkszám
1. króm	160	180	10007652730
	192	210	10007652740
2. matt króm	160	180	10007652731
	192	210	10007652741
3. matt nikkel	160	180	10007652732
	192	210	10007652742

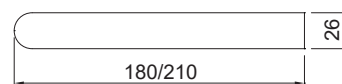
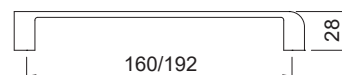

E084-160 - fém



szín	cikkszám
1. króm	10007652750
2. matt króm	10007652751
3. matt nikkel	10007652752

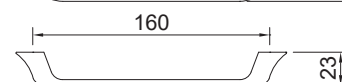
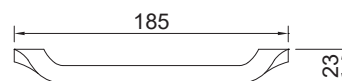

E084-16 - fém



szín	cikkszám
1. króm	10007652760
2. matt króm	10007652761
3. matt nikkel	10007652762

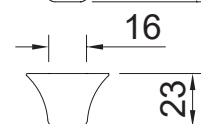
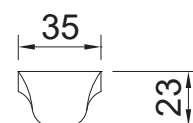

E065-160 - fém



szín	cikkszám
acél	10007652350

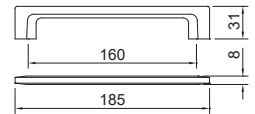

E066-160 - fém



szín	cikkszám
acél	10007652360

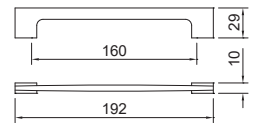

E076-160 - fém



szín	cikkszám
acél	10007652490

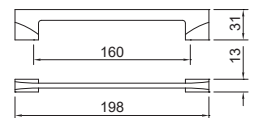

E067 - fém



szín	hosszméret (mm)	furattáv (mm)	cikkszám
acél	137	128	10007652370
	168	160	10007652380

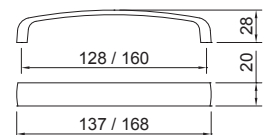

E073-160 - fém



szín	cikkszám
acél	10007652460

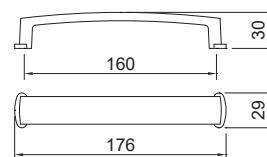

E074-160 - fém



szín	cikkszám
acél	10007652470

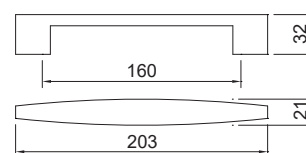

E075-160 - fém



szín	cikkszám
acél	10007652480

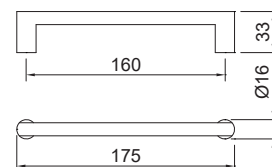

E069-160 - fém



szín	cikkszám
acél	10007652400

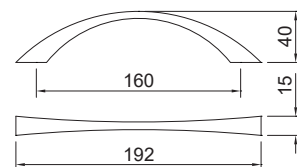

E071-128 - fém



szín	cikkszám
acél	10007652430

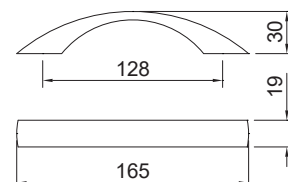

E068-160 - fém



szín	cikkszám
1. acél	10007652390
2. fehér	10007652391
3. fekete	10007652392

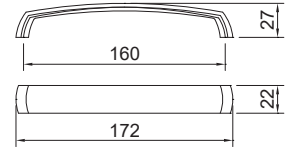

E072 - fém

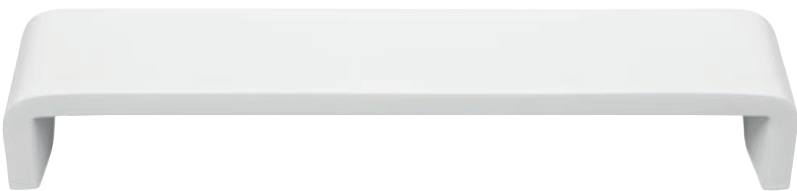

E072-128	cikkszám
1. acél	10007652440
2. fehér	10007652441
3. fekete	10007652442



E072-160	cikkszám
1. acél	10007652450
2. fehér	10007652451
3. fekete	10007652452

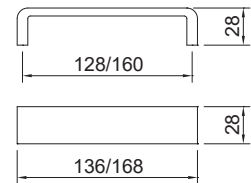

E070 - fém



E070-160	cikkszám
1. acél	10007652410
2. fehér	10007652411
3. fekete	10007652412



E070-320	cikkszám
1. acél	10007652420
2. fehér	10007652421
3. fekete	10007652422

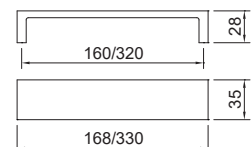

E079 - fém

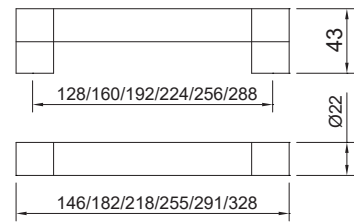

szín	hosszméret (mm)	furattáv (mm)	cikkszám
acél	146	128	10007652530
	182	160	10007652540
	218	192	10007652550
	255	224	10007652560
	291	256	10007652570
	328	288	10007652580

E080 - fém



szín	hosszméret (mm)	furattáv (mm)	cikkszám
1. króm	106	96	10007652590
	138	128	10007652600
	170	160	10007652610
	200	192	10007652620
	267	256	10007652630
2. nikkél	106	96	10007652591
	138	128	10007652601
	170	160	10007652611
	200	192	10007652621
	267	256	10007652631
3. fekete	106	96	10007652592
	138	128	10007652602
	170	160	10007652612
	200	192	10007652622
	267	256	10007652632

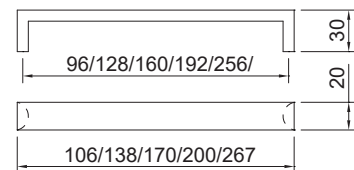

E081 - fém



szín	hosszméret (mm)	furattáv (mm)	cikkszám
1. króm	114	96	10007652640
	153	128	10007652650
	190	160	10007652660
	226	192	10007652670
	290	256	10007652680
	335	320	10007652690
2. nikkell	114	96	10007652641
	153	128	10007652651
	190	160	10007652661
	226	192	10007652671
	290	256	10007652681
	335	320	10007652691
3. fekete	114	96	10007652642
	153	128	10007652652
	190	160	10007652662
	226	192	10007652672
	290	256	10007652682
	335	320	10007652692

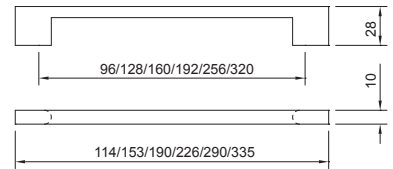

1314-20 - fém



szín	cikkszám
1. króm	10007411560
2. matt króm	10007411561
3. matt nikkell	10007411562

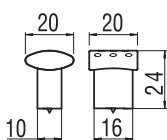

1313-130 - fém



szín	cikkszám
1. króm	10007411550
2. matt króm	10007411551
3. matt nikkell	10007411552

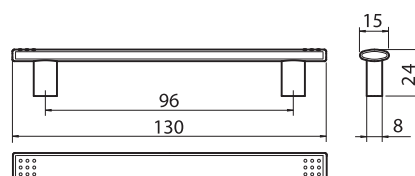

1309-116 - fém



szín	cikkszám
matt nikkell	10007411572

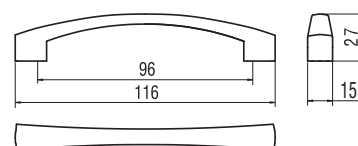

1253-180 - fém



szín	cikkszám
1. króm	10007304140
2. matt nikkell	10007304141
3. réz	10007304142
4. alumínium	10007304143

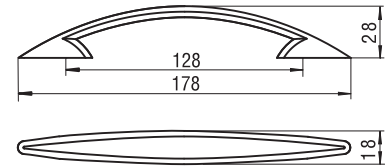
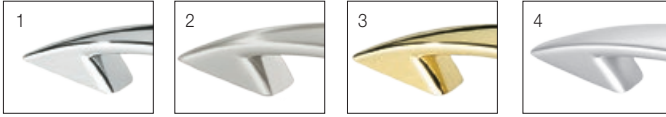

873-28 - fém



szín	cikkszám
1. fekete nikkell	10007410700
2. matt króm	10007410800
3. matt nikkell	10007410900

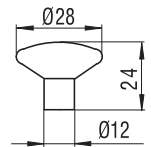

878-128 / 878-160 - fém



878-128	cikkszám
1. króm	10007411100

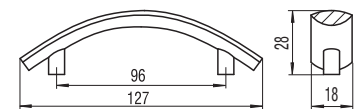

878-160	cikkszám
1. króm	10007411510
2. matt króm	10007411520
3. matt nikkell	10007411530

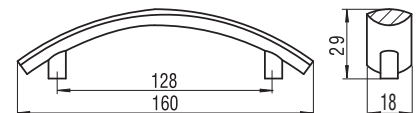

932-16 - fém



szín	cikkszám
matt nikkell	10007416600

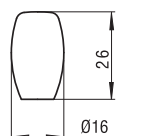

MT 1317-26 - fém



szín	cikkszám
1. króm	10007255010
2. matt króm	10007255013
3. matt nikkel	10007255015

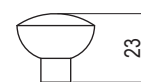
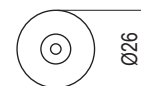

MT 1318-121 - fém



szín	cikkszám
1. matt króm	10007255019
3. matt nikkel	10007255021

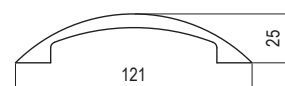
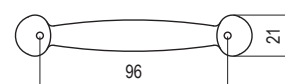

MT 1319-94 - fém



szín	cikkszám
1. króm	10007255023
3. matt nikkel	10007255027

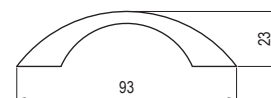
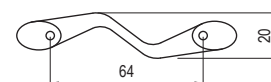

MT 1301-82 - fém



szín	cikkszám
1. króm	10007255029
2. matt króm	10007255031
3. matt nikkel	10007255033

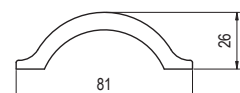
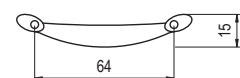

1029-147 - fém

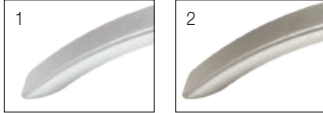
S I R O[®]
www.siro.cc

szín	cikkszám
1. matt króm	10007300052
3. matt nikkell	10007300056

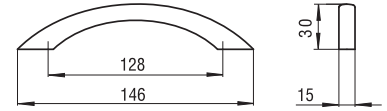

908-110 - fém

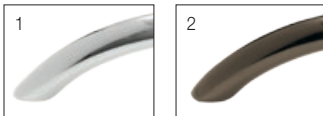

szín	cikkszám
1. króm	10007411600
3. fekete nikkell	10007411700

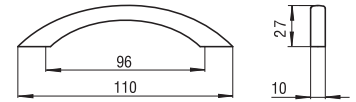

914-102 - fém



szín	cikkszám
1. króm	10007413000
3. fekete nikkell	10007413100
3. réz	10007413200

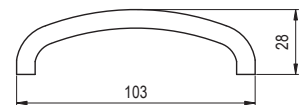
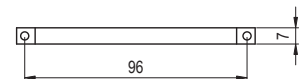

916-135 - fém

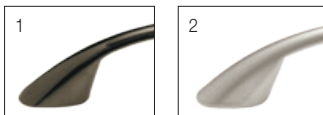

szín	cikkszám
1. fekete nikkell	10007413700
2. matt nikkell	10007413805

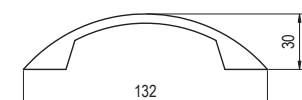
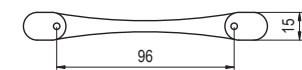

T 250-96 / T 250-128 - fém



T 250-96	cikkszám
1. matt króm	10007601375
3. matt nikkell	10007601376

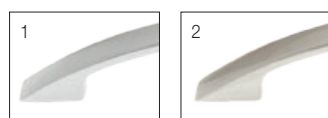
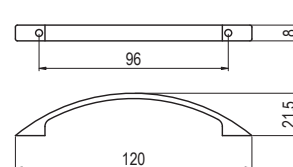

T 250-128	cikkszám
1. matt króm	10007601379
3. matt nikkell	10007601380

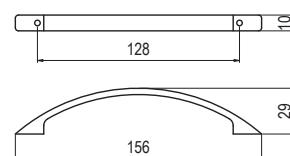

T 252-28 - fém



szín	cikkszám
1. króm	10007601389
2. matt króm	10007601390
3. matt nikkell	10007601393

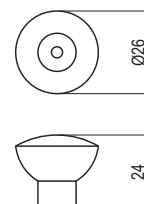

T 253-96 - fém



szín	cikkszám
1. króm	10007601396
2. matt króm	10007601397
3. matt nikkell	10007601398

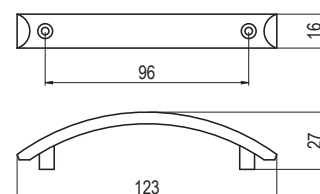

T 255-128 - fém



szín	cikkszám
1. matt króm	10007610010
2. króm	10007610011
3. matt nikkel	10007610012

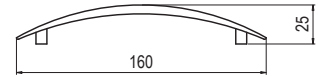
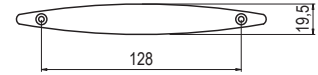

T 232-96 / T 232-128 - fém



T 232-96	cikkszám
1. króm	10007606429
2. matt króm	10007606430
3. réz	10007606431

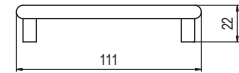
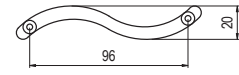

T 232-128	cikkszám
1. króm	10007606432
2. matt króm	10007606433

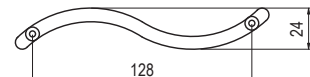

T 204-96 - fém



szín	cikkszám
1. króm	10007602300
2. matt acél	10007602400
3. réz	10007602500

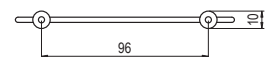

T 243-96 - fém



szín	cikkszám
1. króm	10007601333
2. matt króm	10007601334
3. matt nikkell	10007601335

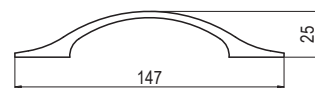
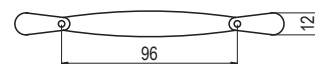

T 236-128 - fém

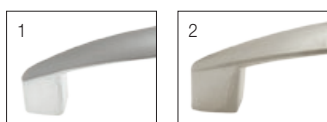

szín	cikkszám
1. matt króm	10007606470
2. nikkell	10007606472

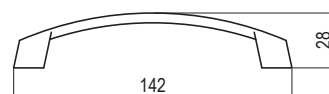
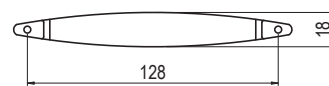

T 238-96 - fém

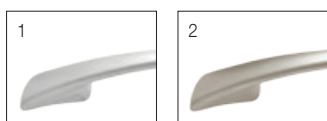

szín	cikkszám
1. matt króm	10007606484
2. matt nikkell	10007606485

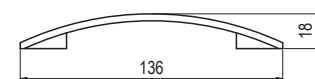
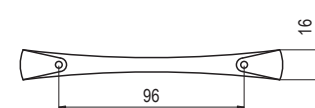

G 955-96 - fém

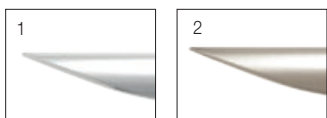

szín	cikkszám
1. króm	10008106000
2. matt nikkell	10008106020

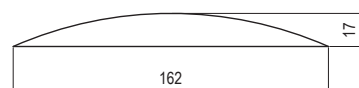
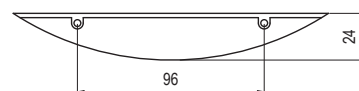

T 244-64 - fém

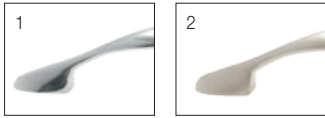

szín	cikkszám
1. króm	10007601339
2. matt nikkkel	10007601340

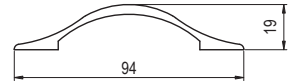
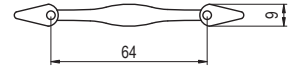

T 244-96 - fém

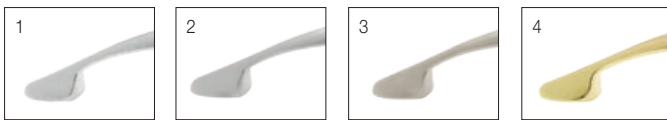

szín	cikkszám
1. króm	10007601343
2. matt króm	10007601344
3. matt nikkkel	10007601345
4. réz	10007601346

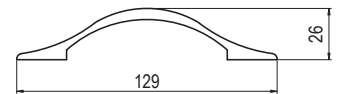
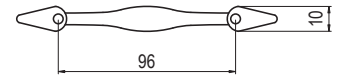

T 256-96 - fém



szín	cikkszám
matt króm	10007610021

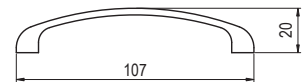
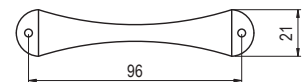

T 258-96 - fém



szín	cikkszám
1. matt króm	10007610040
2. króm	10007610041
3. matt nikkkel	10007610042

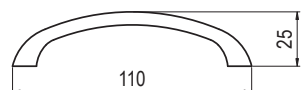
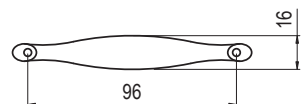

T 259-64 - fém



szín	cikkszám
króm	10007610051

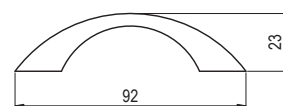
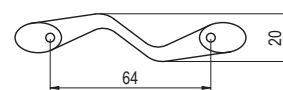

T 254-96 - fém



szín	cikkszám
1. antikolt	10007610000
2. matt fekete	10007610001
3. arany	10007610003
4. króm	10007610004
5. matt króm	10007610005
6. matt nikkell	10007610006

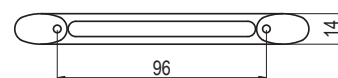

T 241-96 - fém



szín	cikkszám
1. matt fekete	10007601321
2. matt króm	10007601322

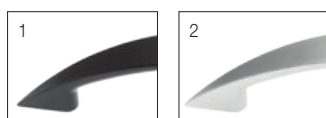
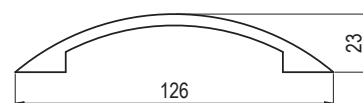
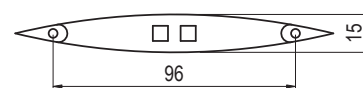

T 233-96 - fém



szín	cikkszám
1. króm	10007606435
2. réz	10007606436
3. matt nikkell	10007606437

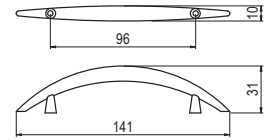

T 234-128 - fém

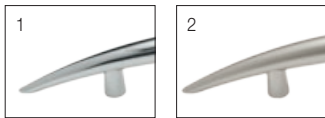

szín	cikkszám
1. króm	10007606438
2. matt nikkell	10007606440

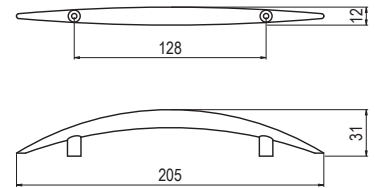

G 980-128 - fém

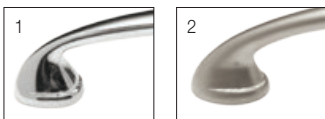

szín	cikkszám
1. króm	10008105500
2. nikkell	10008105600

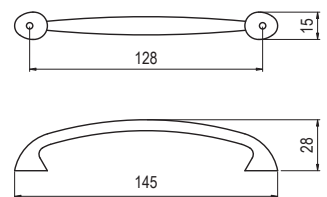

G 980-96 - fém



szín	cikkszám
1. réz	10008104900
2. króm	10008105000
3. nikkell	10008105100
4. fekete nikkell	10008105200
5. alumínium	10008105300

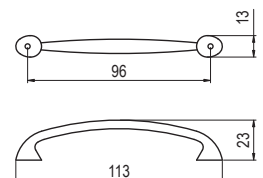

G 972-96 - fém

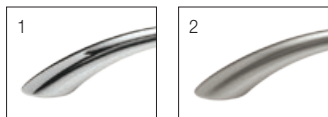

szín	cikkszám
1. króm	10008104400
2. nikkell	10008104405

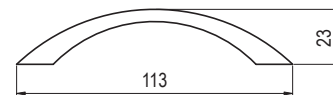
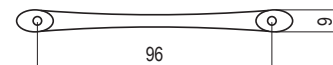

G 1008-64 / G 1008-96 / G 1008-128 - fém



szín	hosszméret (mm)	furattáv (mm)	cikkszám
króm	72	64	10008103600
	104	96	10008103800
	136	128	10008104000

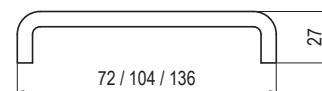
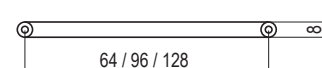

G 982-128 - fém



szín	cikkszám
matt nikkell	10008106120

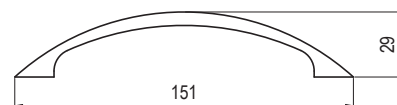
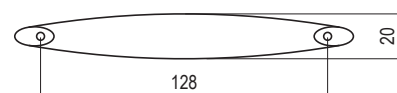

E003-096 - fém

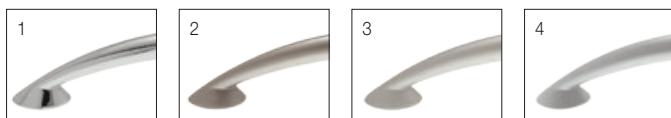

szín	cikkszám
1. króm	10007650400
2. nikkell	10007650401
3. matt nikkell	10007650402
4. matt króm	10007650403

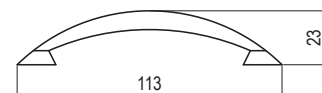
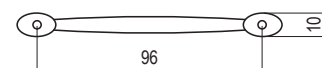

E002-064 / E002-096 / E002-128 - fém



E002-064	cikkszám
1. króm	10007650370
2. nikkel	10007650371
3. matt nikkel	10007650372
4. matt króm	10007650373

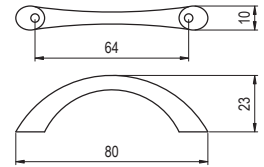

E002-096	cikkszám
1. króm	10007650380
2. nikkel	10007650381
3. matt nikkel	10007650382
4. matt króm	10007650383
5. antikolt	10007650384

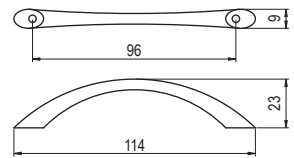

E002-128	cikkszám
1. króm	10007650390
2. nikkel	10007650391
3. matt nikkel	10007650392
4. matt króm	10007650393

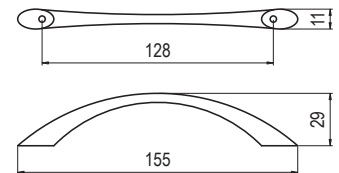

E018-096 / E018-128 - fém

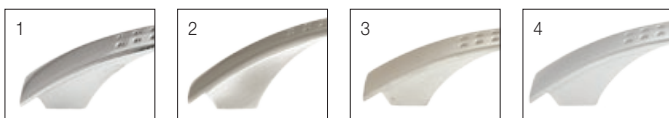

E018-096	cikkszám
1. króm	10007650640
2. nikkel	10007650641
3. matt nikkel	10007650642
4. matt króm	10007650643

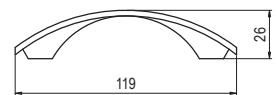
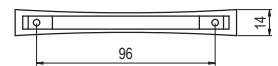

E018-128	cikkszám
1. matt nikkel	10007650652
4. matt króm	10007650653

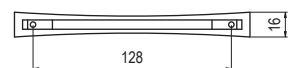

E005-096 / E005-128 - fém



E005-096	cikkszám
1. króm	10007650420
2. nikkell	10007650421
3. matt króm	10007650423

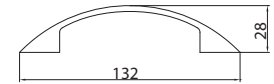
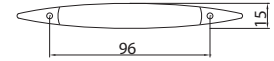

E005-128	cikkszám
1. króm	10007650430
2. nikkell	10007650431
3. matt króm	10007650433

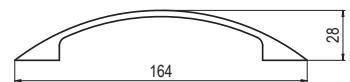
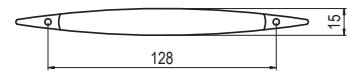

E004-096 - fém



szín	cikkszám
1. króm	10007650410
2. nikkell	10007650411
3. matt króm	10007650413
4. réz	10007650414
5. fekete	10007650415

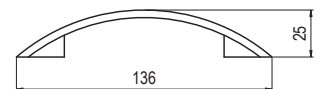
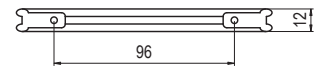

E006-128 - fém

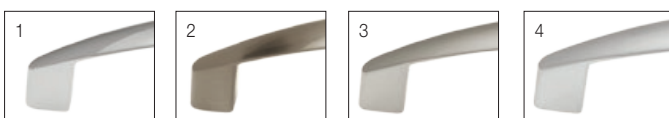

szín	cikkszám
1. króm	10007650450
2. nikkell	10007650451
3. matt nikkell	10007650452
4. matt króm	10007650453

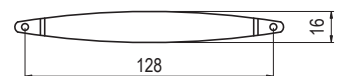

E008-096 / E008-128 - fém



E008-096	cikkszám
1. króm	10007650480
2. nikkell	10007650481
3. matt nikkell	10007650482
4. matt króm	10007650483

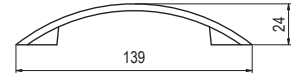
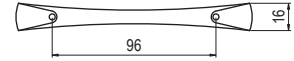

E008-128	cikkszám
1. króm	10007650490
2. nikkell	10007650491
3. matt nikkell	10007650492
4. matt króm	10007650493

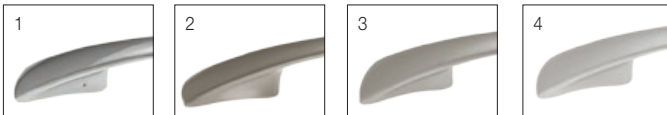
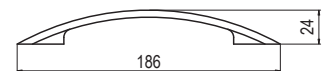
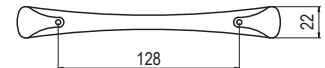

E011-128 - fém



szín	cikkszám
1. króm	10007650540
2. matt nikkell	10007650542
3. matt króm	10007650543

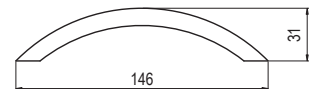
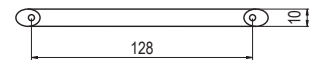

E013-032 - fém



szín	cikkszám
1. króm	10007650560
2. nikkell	10007650561
3. matt króm	10007650563

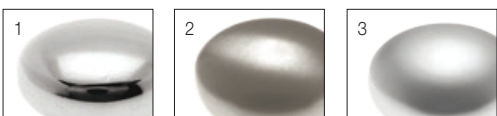

E014-096 - fém



szín	cikkszám
1. króm	10007650570
2. nikkell	10007650571
3. matt nikkell	10007650572
4. matt króm	10007650573

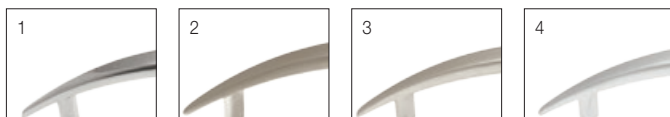
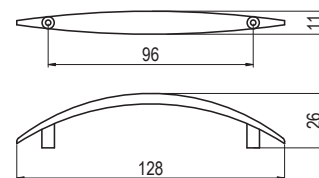

E019-096 / E019-128 - fém



E019-096	cikkszám
1. króm	10007650660
2. nikkell	10007650661
3. matt nikkell	10007650662
4. matt króm	10007650663

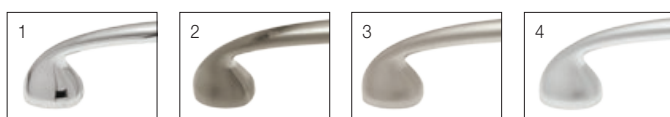
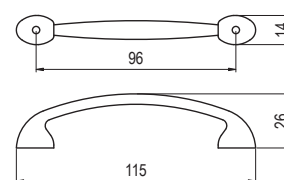

E019-128	cikkszám
1. króm	10007650670
2. nikkell	10007650671
3. matt nikkell	10007650672
4. matt króm	10007650673

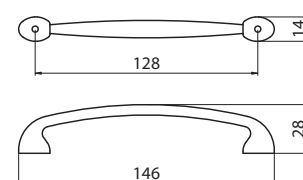

E015-064 / E015-096 / E015-128 - fém

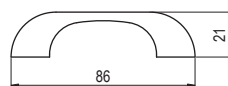
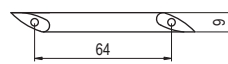

E015-064	cikkszám
1. króm	10007650580
2. nikkell	10007650581
3. matt nikkell	10007650582
4. matt króm	10007650583

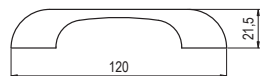
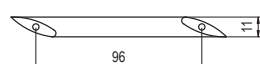

E015-096	cikkszám
1. króm	10007650590
2. nikkell	10007650591
3. matt nikkell	10007650592
4. matt króm	10007650593
5. antikolt	10007650594

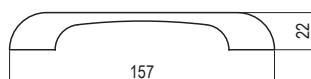
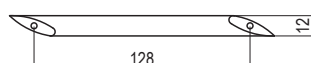

E015-128	cikkszám
1. króm	10007650600
2. nikkell	10007650601
3. matt nikkell	10007650602
4. matt króm	10007650603



E017-096 - fém



szín	cikkszám
1. króm	10007650620
2. nikkel	10007650621
3. matt nikkel	10007650622
4. matt króm	10007650623

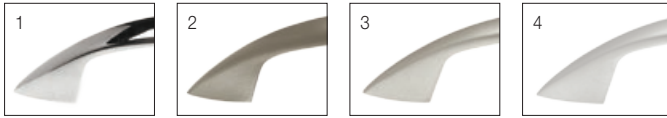
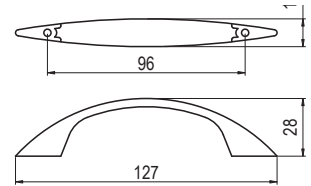

E018-064 - fém



szín	cikkszám
1. króm	10007650630
2. nikkel	10007650631
3. matt nikkel	10007650632
4. matt króm	10007650633

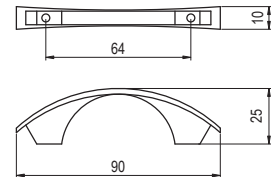

E032-096 - fém



E032-096	cikkszám
1. króm	10007650810
2. nikkel	10007650811
3. matt króm	10007650813
4. antikolt	10007650814

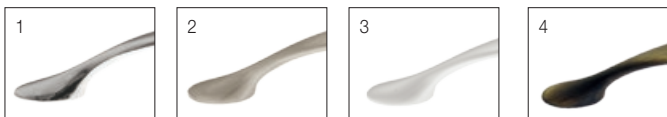
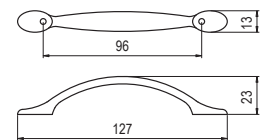

E032-128	cikkszám
1. króm	10007650820
2. nikkel	10007650821
3. matt króm	10007650823

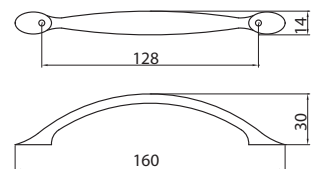

E062 - fém



szín	hossz. (mm)	furattáv (mm)	cikkszám
króm	146	128	10007652220
	178	160	10007652230
	210	192	10007652240
	274	256	10007652250

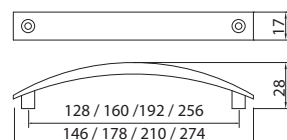

E059 - fém



szín	hossz. (mm)	furattáv (mm)	cikkszám
króm	172	160	10007652150
	268	256	10007652160

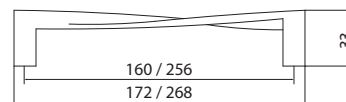

E061 - fém



szín	hossz. (mm)	furattáv (mm)	cikkszám
króm	147	128	10007652200
	211	192	10007652210

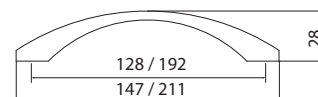

E060 - fém



szín	hossz. (mm)	furattáv (mm)	cikkszám
króm	165	128	10007652170
	229	192	10007652180
	293	256	10007652190

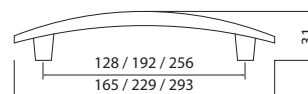

BR-189 - fém



szín	hossz. (mm)	furattáv (mm)	cikkszám
1. matt króm	155	128	10007700121
2. matt nikkel	155	128	10007700122
	229	192	10007700142

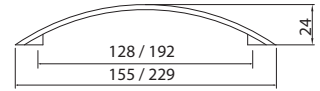
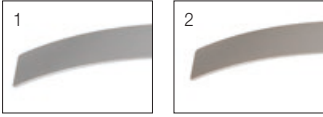

BR-512 - fém



szín	cikkszám
1. matt króm	10007700181
2. krém	10007700182
3. sötétbarna	10007700183

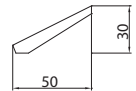
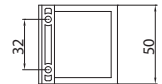

EM-053 - fém



szín	cikkszám
1. króm	10007700010
2. matt króm	10007700011

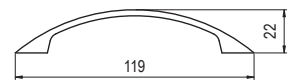
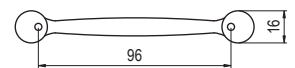
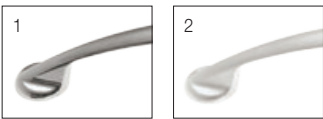

EM-022 - fém

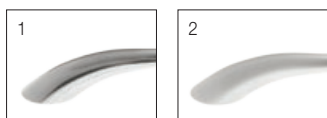

szín	cikkszám
1. króm	10007700020
2. matt króm	10007700021

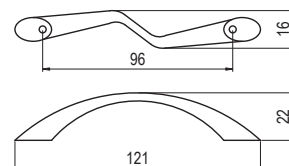

EM-093 - fém

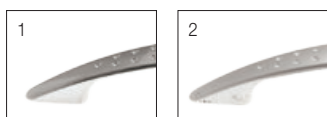

szín	cikkszám
1. króm	10007700030
2. matt króm	10007700031

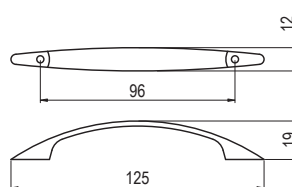

EM-011-E - fém

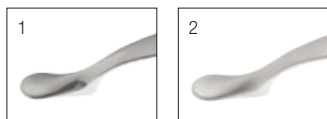

szín	cikkszám
1. króm	10007700040
2. matt króm	10007700041

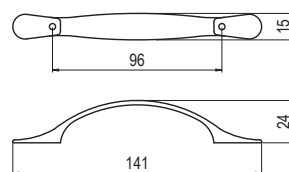

EM-054 - fém

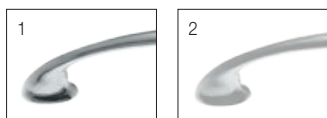

szín	cikkszám
1. króm	10007700000
2. matt króm	10007700001

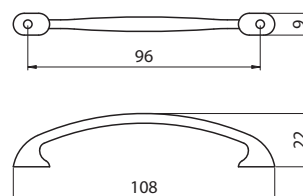

EM-013-D - fém



szín	cikkszám
1. króm	10007700050
2. matt króm	10007700051

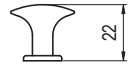
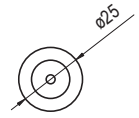

T 306-26 - fém / műanyag



szín	cikkszám
acryl - króm	10007607900

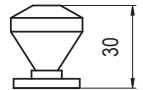
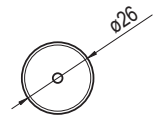

1095-90 - fém



szín	cikkszám
1. króm	10007300100
2. matt króm	10007300200

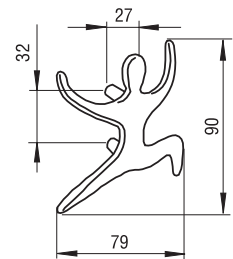

SIRO
www.siro.cc



913-32 - fém



szín	cikkszám
1. króm	10007412800
2. réz	10007412900

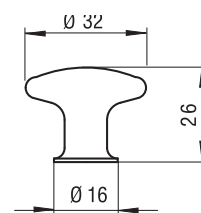

G 798-30 - fém



szín	cikkszám
1. réz	10008102100
2. króm	10008102200

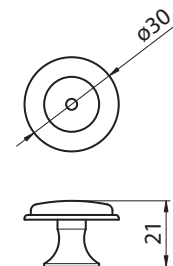

G 144-19 - fém



szín	cikkszám
króm	10008100477

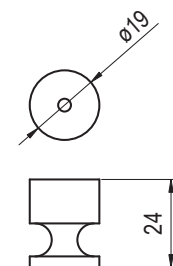

G 143-25 - fém



szín	cikkszám
króm	10008100462

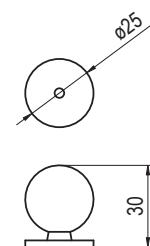

550.096 / 550.128 - fém / kristály



550.096	cikkszám
1. matt alumínium - Swarovski kristály	10007552000
2. fekete nikkell - Swarovski kristály	10007552002
3. arany - Swarovski smaragd kristály	10007552003

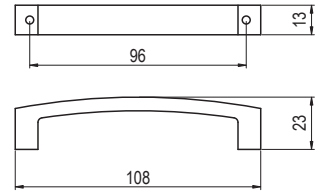

550.128	cikkszám
króm - Swarovski kristály	10007552030

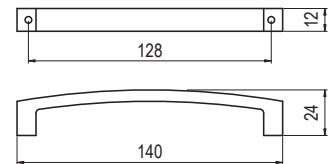

550.016 - fém / kristály



szín	cikkszám
1. matt alumínium - Swarovski kristály	10007552010
2. fekete nikkell - Swarovski zöld opál kristály	10007552011
3. fekete nikkell - Swarovski kristály	10007552012
4. arany - Swarovski smaragd kristály	10007552013

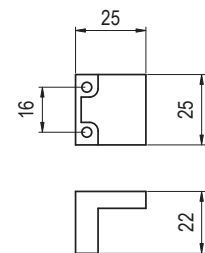

552.025 - fém / kristály



szín	cikkszám
króm - Swarovski kristály	10007552040

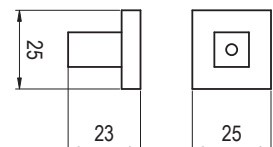

550.000 - fém / kristály



szín	cikkszám
króm - Swarovski kristály	10007552050

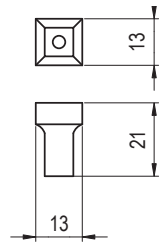

550.032 - fém / kristály



szín	cikkszám
1. fekete nikkell - Swarovski zöld opál kristály	10007552021
2. fekete nikkell - Swarovski kristály	10007552022
3. arany - Swarovski smaragd kristály	10007552023

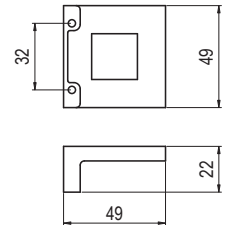

633.128 / 633.096 / 633.032 / 633.017 - fém / kristály

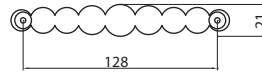

633.128	cikkszám
2. nikkell - Swarovski kristály	10007552162
3. króm - Swarovski kristály	10007552160

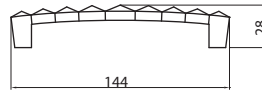

633.096	cikkszám
3. króm - Swarovski kristály	10007552140

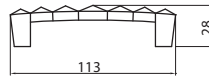

633.C32	cikkszám
2. nikkell - Swarovski kristály	10007552151
3. króm - Swarovski kristály	10007552152

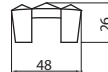
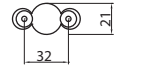

633.017	cikkszám
1. fekete - Swarovski kristály	10007552130
2. nikkell - Swarovski kristály	10007552131
3. króm - Swarovski kristály	10007552132



633.A64 - fém / kristály



szín	cikkszám
króm - Swarovski kristály	10007552170

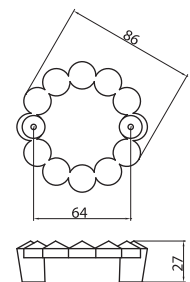

633.B32 - fém / kristály



szín	cikkszám
1. króm - Swarovski kristály	10007552180
2. fekete - Swarovski kristály	10007552182

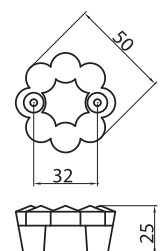

640.096 / 640.032 / 640.016 - fém / kristály

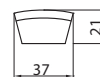
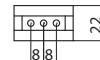
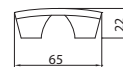
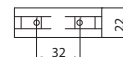
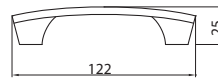
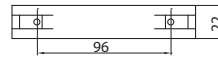

640.096	cikkszám
1. fekete - Swarovski kristály	10007552191
2. nikkell - Swarovski kristály	10007552190

640.032	cikkszám
1. fekete - Swarovski kristály	10007552201
2. nikkell - Swarovski kristály	10007552200

640.016	cikkszám
1. fekete - Swarovski kristály	10007552210
2. nikkell - Swarovski kristály	10007552211



693.015 - fém / kristály



szín	cikkszám
1. nikkell - Swarovski kristály	10007552280
2. fekete - Swarovski kristály	10007552281

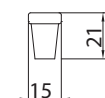

693.031 - fém / kristály



szín	cikkszám
1. nikkell - Swarovski kristály	10007552290
2. fekete - Swarovski kristály	10007552291

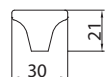

693.032 - fém / kristály



szín	cikkszám
1. nikkal - Swarovski kristály	10007552300
2. fekete - Swarovski kristály	10007552301

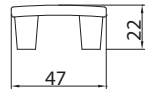
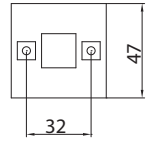

693.096 / 693.128 - fém / kristály

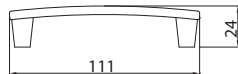
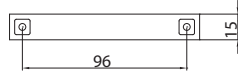

szín	cikkszám
1. nikkal - Swarovski kristály	10007552310
2. fekete - Swarovski kristály	10007552311

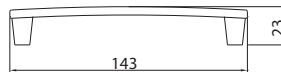
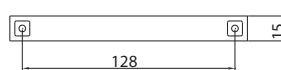

szín	cikkszám
1. nikkal - Swarovski kristály	10007552320
2. fekete - Swarovski kristály	10007552321

667.016 - fém / kristály



szín	cikkszám
1. nikkal - Swarovski kristály	10007552330
2. fekete - Swarovski kristály	10007552331

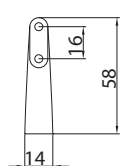
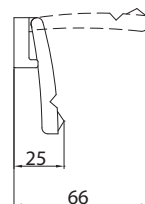

667.128 / 667.096 - fém / kristály

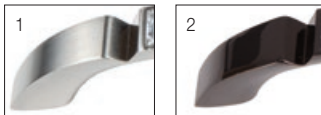
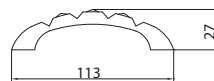
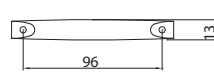
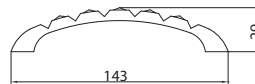
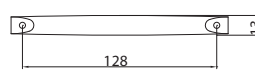

667.128	cikkszám
1. nikkal - Swarovski kristály	10007552360
2. fekete - Swarovski kristály	10007552361

667.096	cikkszám
1. nikkal - Swarovski kristály	10007552350
2. fekete - Swarovski kristály	10007552351

694.160 / 694.128 / 694.096 / 694.000 - fém / kristály

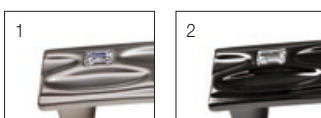
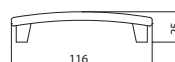
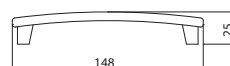
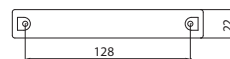
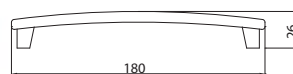
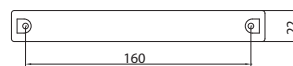

694.160	cikkszám
1. nikkal - Swarovski kristály	10007552270
2. fekete - Swarovski kristály	10007552271

694.128	cikkszám
1. nikkal - Swarovski kristály	10007552260
2. fekete - Swarovski kristály	10007552261

694.096	cikkszám
1. nikkal - Swarovski kristály	10007552250
2. fekete - Swarovski kristály	10007552251

694.000	cikkszám
1. nikkal - Swarovski kristály	10007552240
2. fekete - Swarovski kristály	10007552241

655.016 - fém / kristály



szín	cikkszám
1. króm - Swarovski kristály	10007552220
2. nikkél - Swarovski kristály	10007552221
3. antik - Swarovski kristály	10007552222

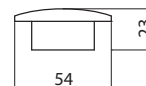
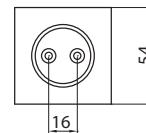

655.000 - fém / kristály



szín	cikkszám
1. króm - Swarovski kristály	10007552230
2. nikkél - Swarovski kristály	10007552231
3. antik - Swarovski kristály	10007552232

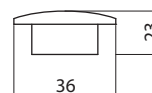
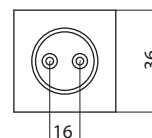

550.096 - fém / csillám



szín	cikkszám
1. króm - csillám ezüst	10007552100

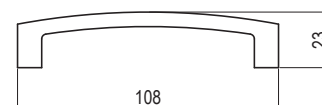
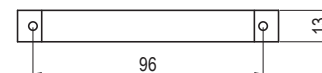

550.032 - fém / csillám

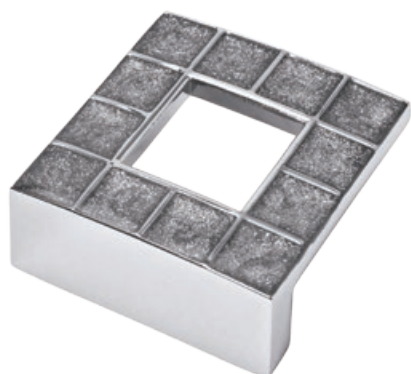

szín	cikkszám
1. króm - csillám ezüst	10007552120

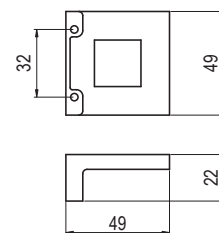

2006-91 - fém



szín	cikkszám
1. antikolt	10007306530
2. antikolt ezüst	10007306531

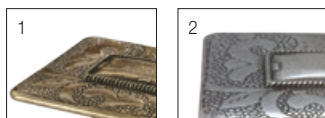
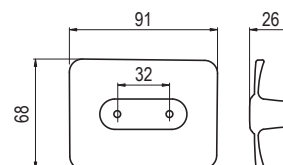

2015-54 - fém



szín	cikkszám
1. antikolt	10007306480
2. antikolt réz	10007306481

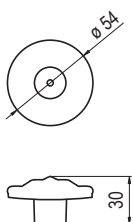

1874-365 - fém

SIRO®
www.siro.cc

szín	cikkszám
antikolt	10007306520

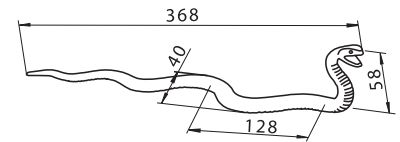

1696-335 - fém

szín	cikkszám
antikolt	10007306500



1697-376 - fém

szín	cikkszám
antikolt	10007306510

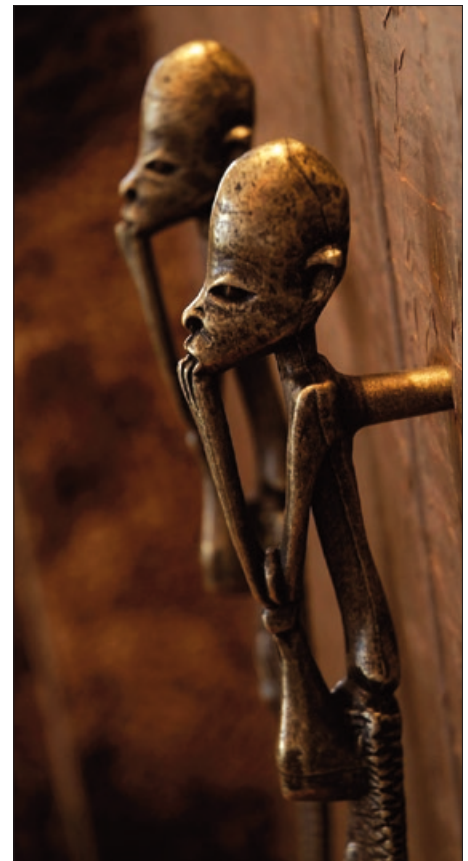
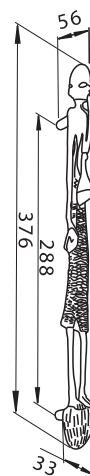

2076-24 - fém

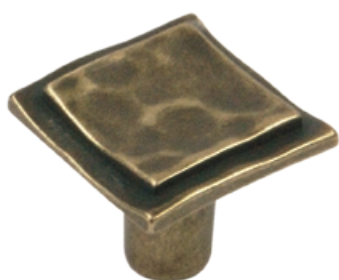

szín	cikkszám
antikolt	10007306560

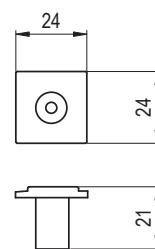

2039-38 - fém



szín	cikkszám
antikolt	10007306590

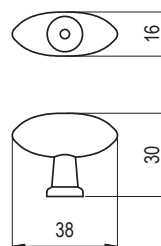

2075-93 - fém



szín	cikkszám
antikolt	10007306561

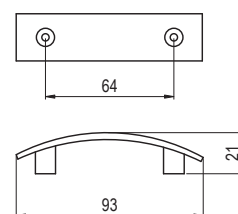

2026-40 - fém



szín	cikkszám
1. króm	10007306570
2. antikolt	10007306571

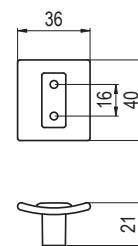

1268-51 / 1268-62 - fém



1268-51	cikkszám
1. antikolt	10007304171
3. matt fekete	10007304172

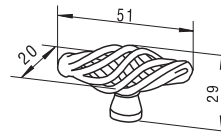

1268-51	cikkszám
1. antik ón	10007304180
2. antikolt	10007304181
3. matt fekete	10007304182

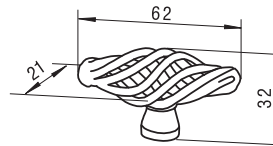

1304-104 / 1304-136 - fém



1304-104	cikkszám
1. antik ón	10007304210
2. antikolt	10007304211
3. matt fekete	10007304212

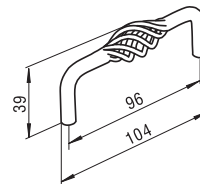

1304-136	cikkszám
2. antikolt	10007304221
3. matt fekete	10007304222

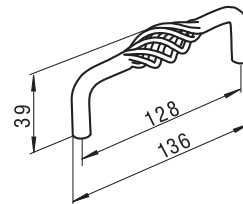

1209-30 / 1209-40 - fém



1209-30	cikkszám
antikolt ezüst	10007303950

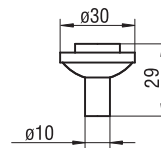

1209-40	cikkszám
antikolt ezüst	10007303960

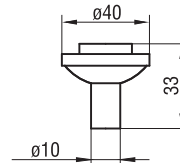

1368-33 / 1368-42 - fém



1368-33	cikkszám
antikolt	10007304270

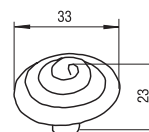

1368-42	cikkszám
antikolt	10007304280

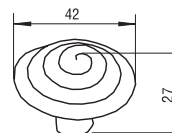

1021-146 - fém

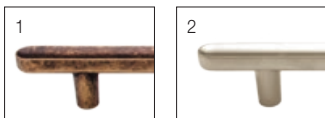

szín	cikkszám
1. antikolt	10007300028
2. matt nikkel	10007300036

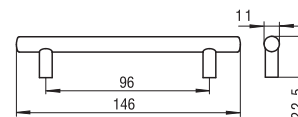

479-106 - fém



szín	cikkszám
antikolt	10007409650

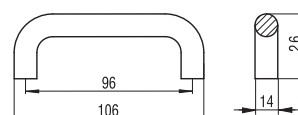

C2040 - fém

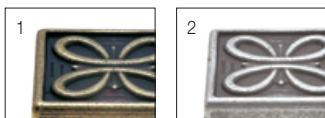

szín	cikkszám
1. matt bronz	10007500400
2. antik ezüst	10007500405

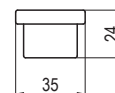
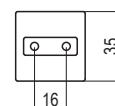

C1020B / C1020C - fém

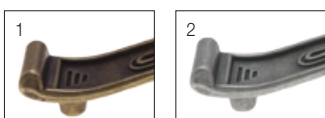

C1020B	cikkszám
1. matt bronz	10007500410
2. antik ezüst	10007500415

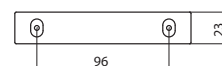
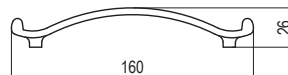
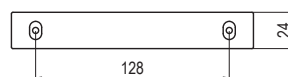

C1020C	cikkszám
1. matt bronz	10007500412
2. antik ezüst	10007500417

563-105 - fém

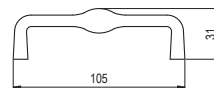
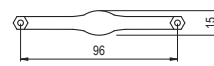

szín	cikkszám
antikolt	10007409672

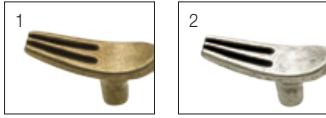

1051-128 - fém

SIRO®
www.siro.cc

szín	cikkszám
1. antikolt	10007418830
2. antik ezüst	10007418836

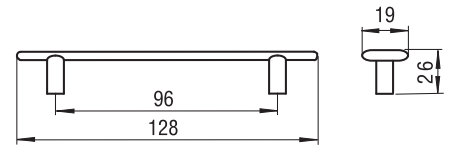

1052-126 - fém



szín	cikkszám
1. antikolt	10007418840
2. antik ezüst	10007418845

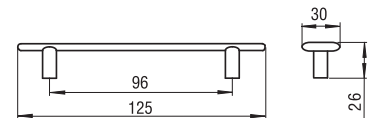

1053-140 - fém



szín	cikkszám
1. antikolt	10007418848
2. antik ezüst	10007418854

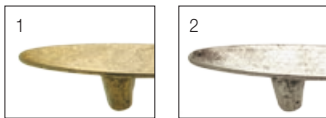
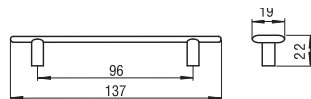

1058-40 - fém



szín	cikkszám
1. antikolt	10007418875
2. antik ezüst	10007418881

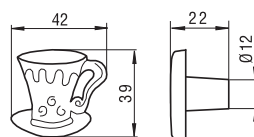

C2041C - fém



szín	cikkszám
1. matt bronz	10007500440
2. antik ezüst	10007500445
3. fekete	10007500450
4. fehér	10007500455

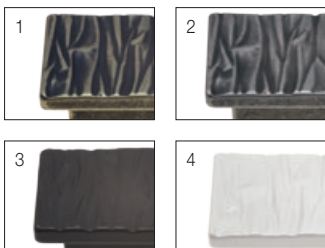
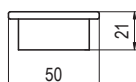
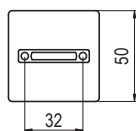

C369B / C369C - fém

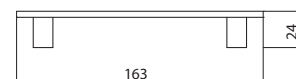
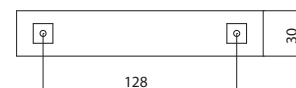
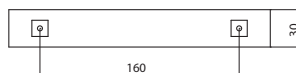

C369B	cikkszám
1. antik ezüst	10007500710
2. matt bronz	10007500711
3. fényes fekete	10007500712
4. fényes fehér	10007500713

C369C	cikkszám
1. antik ezüst	10007500720
2. matt bronz	10007500721
3. fényes fekete	10007500722
4. fényes fehér	10007500723

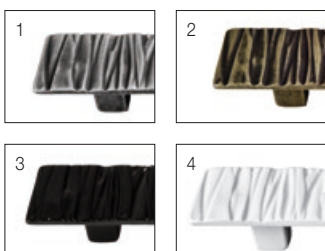

1197-110 - fém



szín	cikkszám
1. kovácsoltvas	10007306000
2. antikolt	10007306100

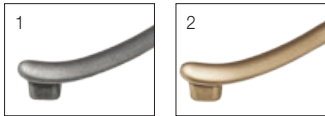
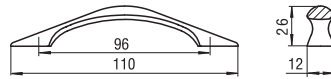

1198-147 - fém



szín	cikkszám
1. kovácsoltvas	10007306200
2. antikolt	10007306300

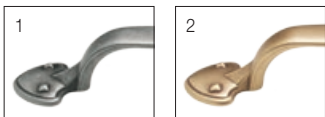
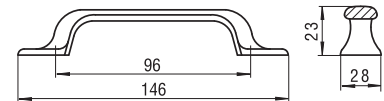

920-28 - fém



szín	cikkszám
1. króm	10007414700
2. antikolt	10007414800
3. réz	10007414900

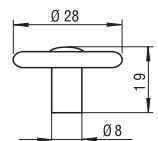

921-127 - fém



szín	cikkszám
1. króm	10007415000
2. antikolt	10007415100
3. fekete nikkelt	10007415200

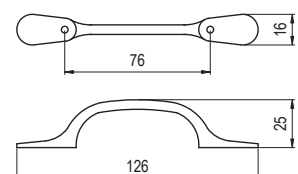

T 229-76 - fém



szín	cikkszám
antikolt	10007606422

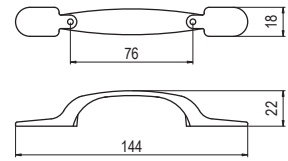

T 231-92 - fém



szín	cikkszám
antikolt	10007606428

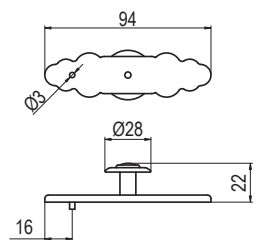

G 681/B-30 - fém



szín	cikkszám
1. réz	10008101000
2. króm	10008101100
3. antikolt	10008101200

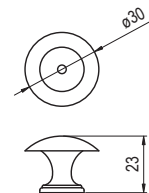

G 682-30 - fém



szín	cikkszám
1. antikolt	10008101244
2. bronz	10008101246

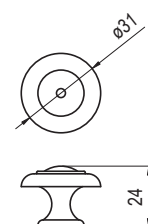

812-86 / 812-120 - fém



812-86	cikkszám
antikolt	10007410230

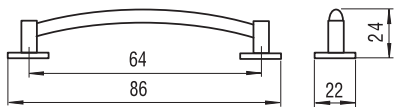

812-120	cikkszám
antikolt	10007410235

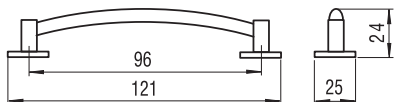

922-113 - fém

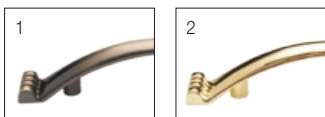

szín	cikkszám
1. antikolt	10007415400
2. réz	10007415500

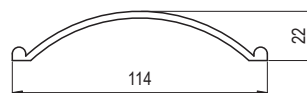
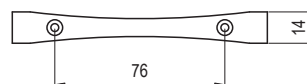

924-108 - fém



szín	cikkszám
antikolt	10007415800

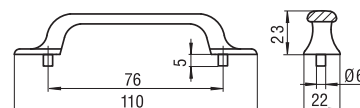

356-97 - fém



szín	cikkszám
antikolt	10007409630

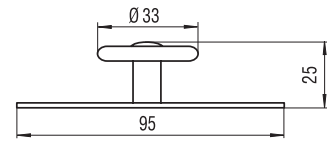

495-112 - fém



szín	cikkszám
antikolt	10007409660

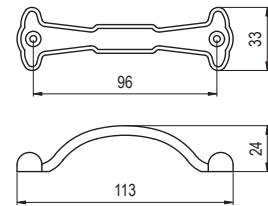

947-102 / 947-86 - fém



947-102	cikkszám
1. antikolt	10007416800

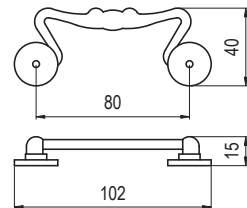

947-86	cikkszám
1. antikolt	10007417000
2. fekete nikkel	10007417100

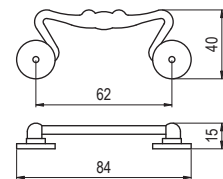

959-45 - fém



szín	cikkszám
1. antikolt	10007418200
2. réz	10007418300

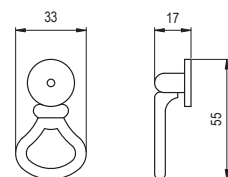

397-23 / 397-35 - fém

SIRO®
www.siro.cc

397-23	cikkszám
antikolt	10007303651

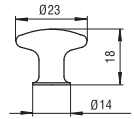

397-35	cikkszám
antikolt	10007303661

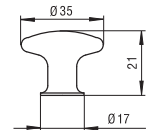

398-70 / 398-98 - fém



398-70	cikkszám
antikolt	10007303681

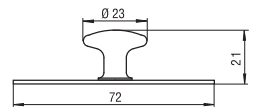

398-98	cikkszám
antikolt	10007303691

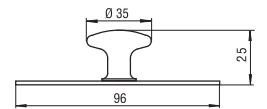

1546-137 - fém



szín	cikkszám
1. antikolt	10007304550
2. antikolt ezüst	10007304551

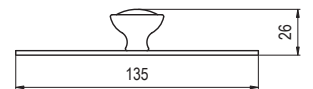

1536-122 - fém



szín	cikkszám
antikolt	10007304490

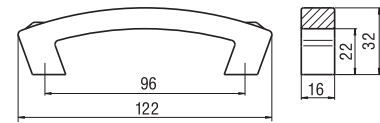

1548-18 - fém



szín	cikkszám
antikolt	10007304560

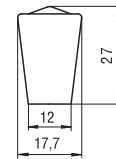

1969-68 - fém

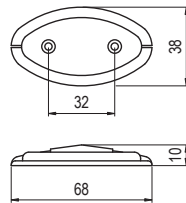

szín	cikkszám
antikolt réz	10007305010



1970-68 - fém



szín	cikkszám
antikolt réz	10007305020

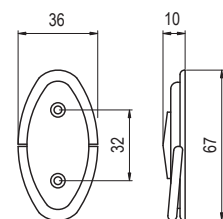

1818-30 - fém



szín	cikkszám
antikolt réz	10007306380

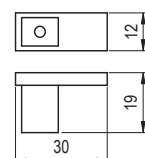

1816-69 - fém

SIRO®
www.siro.cc

szín	cikkszám
1. nikkél	10007304925
2. antik réz	10007304926

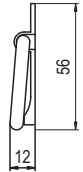
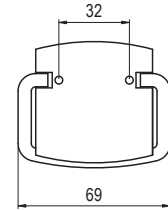

1816-44 - fém



szín	cikkszám
1. nikkél	10007304920
2. antik réz	10007304921

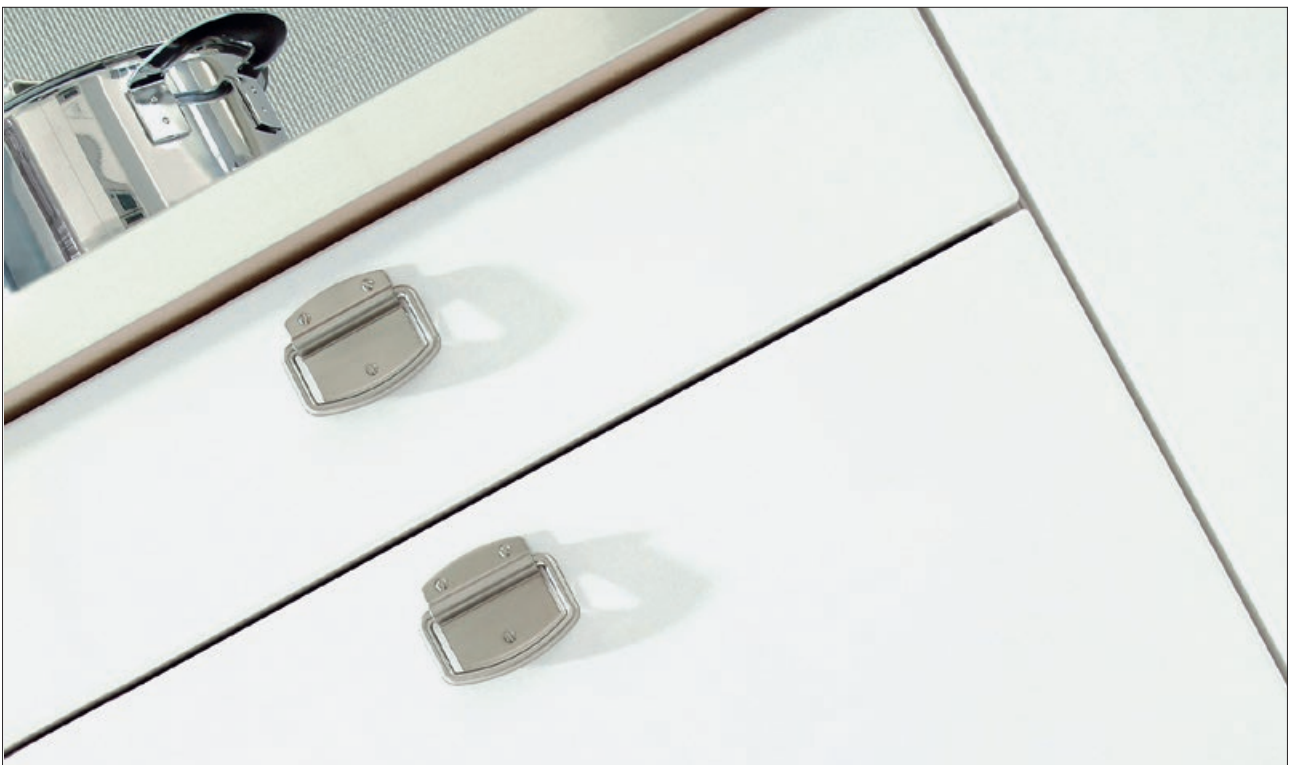
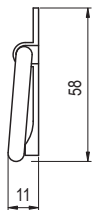
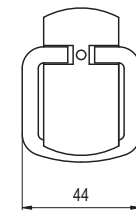

1916-136 - fém



szín	cikkszám
antikolt ezüst	10007304960

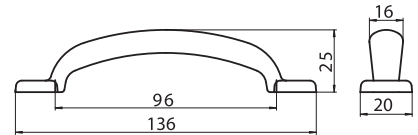

1974-18 - fém



szín	cikkszám
antikolt réz	10007306410

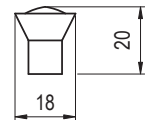
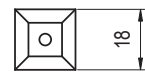

1987-140 - fém



szín	cikkszám
1. antikolt ezüst	10007306370
2. antikolt réz	10007306371
3. króm	10007306372

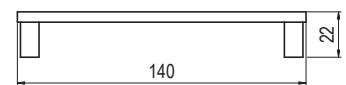
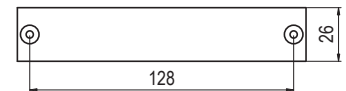

1986-44 - fém



szín	cikkszám
1. antikolt réz	10007306351
2. króm	10007306352

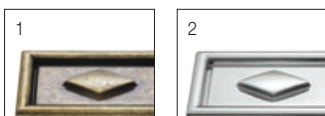
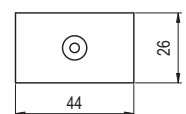

969-46 - fém

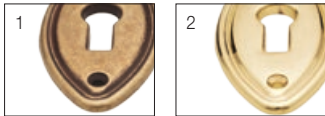
S I R O[®]
www.siro.cc

szín	cikkszám
1. antikolt	10007418700
2. réz	10007418800

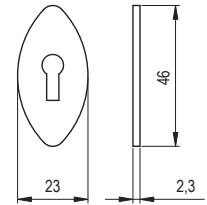

1984-30 - fém



szín	cikkszám
antikolt réz	10007306390

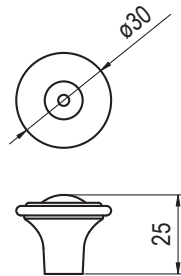

2029-19 - fém



szín	cikkszám
antikolt	10007305200

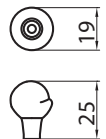

1985-145 - fém



szín	cikkszám
antikolt réz	10007306400

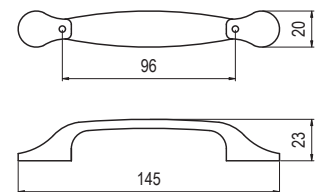

2129-112 - fém



szín	cikkszám
antikolt	10007306630

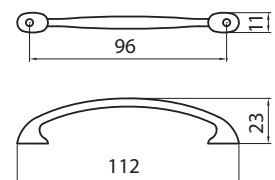



533-128 / 533-96 - fém



533-128	cikkszám
antik Firenze	10007550990

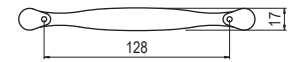

533-96	cikkszám
antik Firenze	10007550980

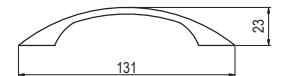
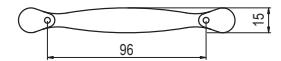

532-128 / 532-96 - fém



532-128	cikkszám
1. antik Firenze	10007551100
2. nikkell	10007551101

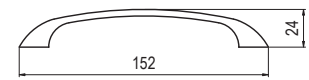
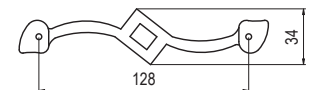

532-96	cikkszám
1. antik Firenze	10007551110
2. nikkell	10007551111

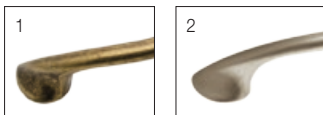
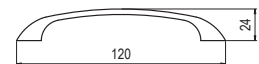
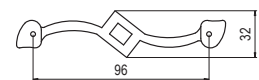

534-128 / 534-96 - fém



534-128	cikkszám
1. antik Firenze	10007551130
2. nikkell	10007551131

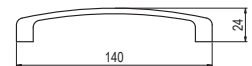
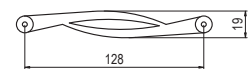

534-96	cikkszám
1. antik Firenze	10007551120
2. nikkell	10007551121

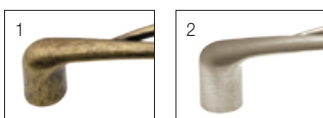
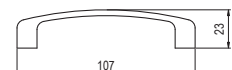
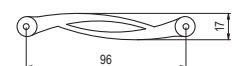

504-96 / 504-32 - fém

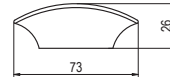
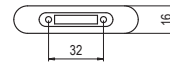
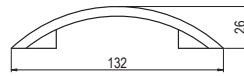
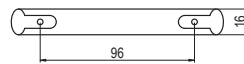

504-96	cikkszám
antikolt bronz	10007550600

504-32	cikkszám
antikolt bronz	10007550610

229-96 / 229-30 - fém

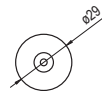
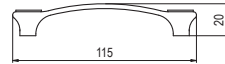
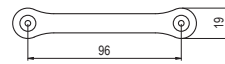

229-96	cikkszám
antikolt bronz	10007550780

229-30	cikkszám
antikolt bronz	10007550790

221-96 / 221-64 - fém

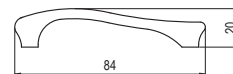
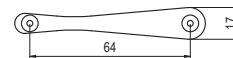
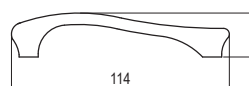
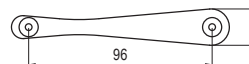

221-96	cikkszám
antik Firenze	10007550950

221-64	cikkszám
antik Firenze	10007550960

133-128 / 133-96 - fém

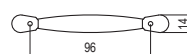

133-128	cikkszám
antik Firenze	10007551010

133-96	cikkszám
antik Firenze	10007551000



503-96 / 503-000 - fém

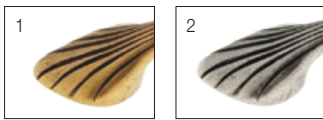

503-96	cikkszám
1. antikolt bronz	10007550620
2. antikolt ezüst	10007550621

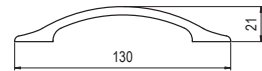
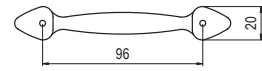

503-000	cikkszám
1. antikolt bronz	10007550630
2. antikolt ezüst	10007550631

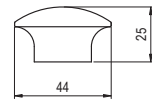
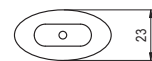

501-96 / 501-000 - fém

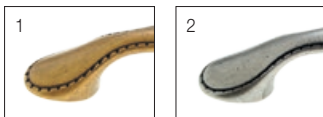

501-96	cikkszám
1. antikolt bronz	10007550820
2. antikolt ezüst	10007550821

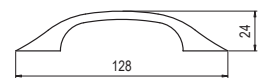
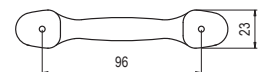

501-000	cikkszám
1. antikolt bronz	10007550830
2. antikolt ezüst	10007550831

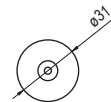

216-96 - fém



szín	cikkszám
antik Firenze	10007550970

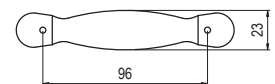

228-96 - fém



szín	cikkszám
antikolt bronz	10007550740

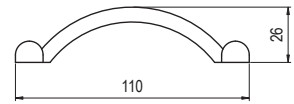
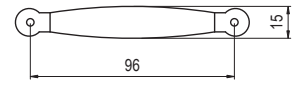

114-000 - fém



szín	cikkszám
antikolt bronz	10007550690

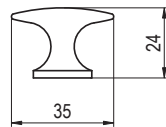
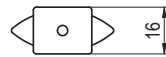

118-000 - fém



szín	cikkszám
antikolt bronz	10007550770

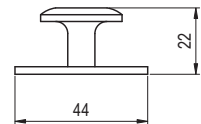
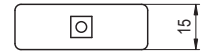

215-96 - fém



szín	cikkszám
antikolt bronz	10007550840

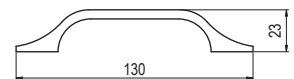
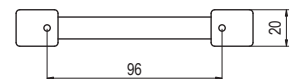

115-000 - fém



szín	cikkszám
1. antikolt bronz	10007550850
2. nikkelt	10007550851

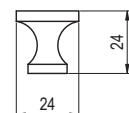
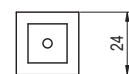

231-96 / 231-128 - fém

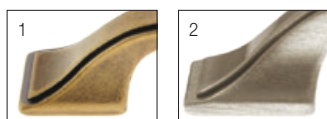

231-96	cikkszám
1. antikolt bronz	10007550750
2. nikkell	10007550751

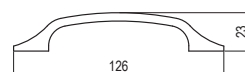
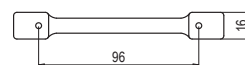

231-128	cikkszám
2. nikkell	10007550755

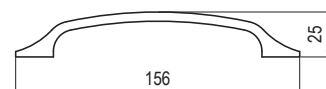
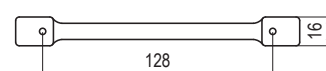

226-96 / 226-24 - fém



226-96	cikkszám
antikolt bronz	10007550700

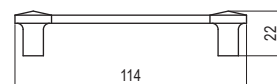
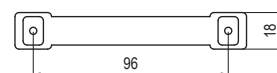

226-24	cikkszám
antikolt bronz	10007550710

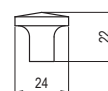
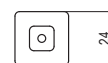

218-96 - fém



szín	cikkszám
antikolt bronz	10007550760

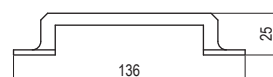
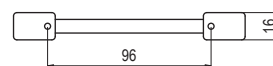

214-96 - fém



szín	cikkszám
antikolt bronz	10007550680

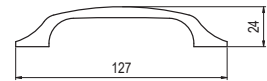
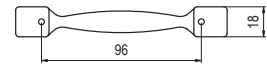

224-96 - fém



szín	cikkszám
1. antikolt bronz	10007550720
2. nikkell	10007550721

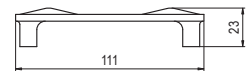
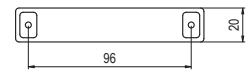

224-16 - fém



szín	cikkszám
1. antikolt bronz	10007550730
2. nikkell	10007550731

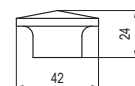
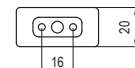

225-96 / 225-16 - fém



225-96	cikkszám
antikolt bronz	10007550640

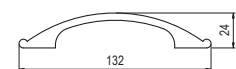
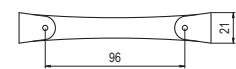

225-16	cikkszám
antikolt bronz	10007550650

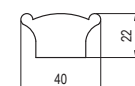
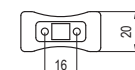

752.000 / 752.096 / 752.128 / 752.160 - fém

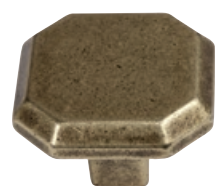

szín	hosszméret (mm)	furattáv (mm)	cikkszám
antik Firenze	gomb 32x32		10007552500
	110	96	10007552510
	142	128	10007552520
	174	160	10007552530

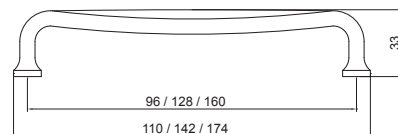
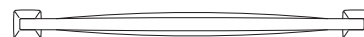
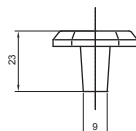
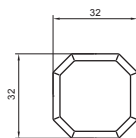

555.096 / 555.128 / 555.160 - fém



szín	hosszméret (mm)	furattáv (mm)	cikkszám
antik Firenze	110	96	10007552580
	142	128	10007552590
	174	160	10007552600

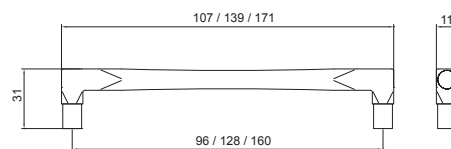

514-96 / 514-000 - fém



514-96	cikkszám
antikolt bronz	10007550890

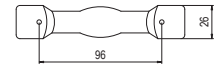

514-000	cikkszám
antikolt bronz	10007550900

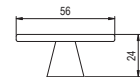
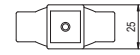

515-96 - fém



szín	cikkszám
antikolt bronz	10007550910

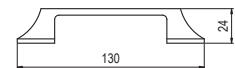
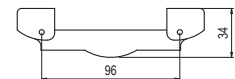

515-000 - fém



szín	cikkszám
antikolt bronz	10007550920

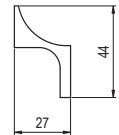

7115/42 - fém díszítő elem



szín	cikkszám
antikolt bronz	10007550930

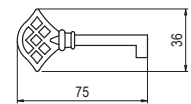

518-000 - fém



szín	cikkszám
antikolt bronz	10007550940

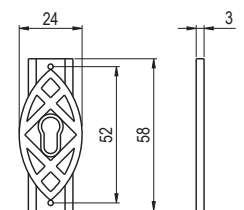

222-96 / 222-32 - fém



222-96	cikkszám
antikolt bronz	10007550800

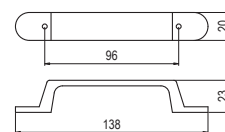

222-32	cikkszám
antikolt bronz	10007550810

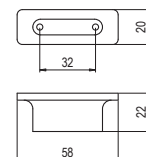

232-96 / 232-32 - fém



232-96	cikkszám
antikolt bronz	10007550860

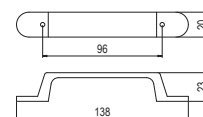

232-32	cikkszám
antikolt bronz	10007550870

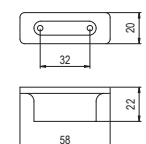

5091 - fém



szín	cikkszám
antikolt	10007550560

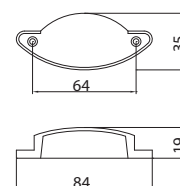

516-96 - fém



szín	cikkszám
antikolt	10007550880

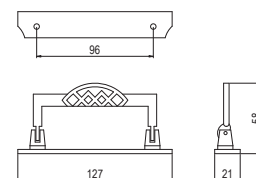

2025-25 / 2025-35 - fém

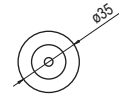
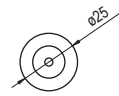
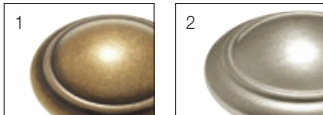

2025-25	cikkszám
1. antikolt	10007550500
2. nikkelt	10007550501

2025-35	cikkszám
1. antikolt	10007550510
2. nikkelt	10007550511

5059 - fém



szín	cikkszám
antikolt	10007550530

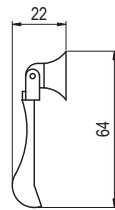

szín	cikkszám
antikolt	10007550520

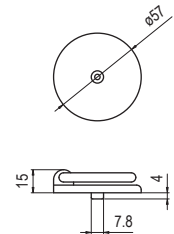

5042/A / 5042/B - fém

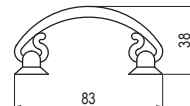
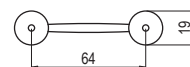
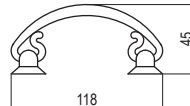
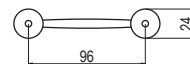

5042/A	cikkszám
antikolt	10007550540

5042/B	cikkszám
antikolt	10007550550

5031/A / 5031/B - fém

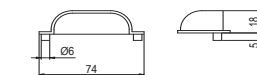
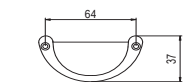
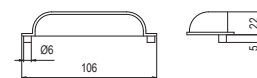
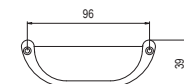

5031/A	cikkszám
antikolt	10007550590

5031/B	cikkszám
antikolt	10007550580

604.032 / 604.096 / 604.128 - fém

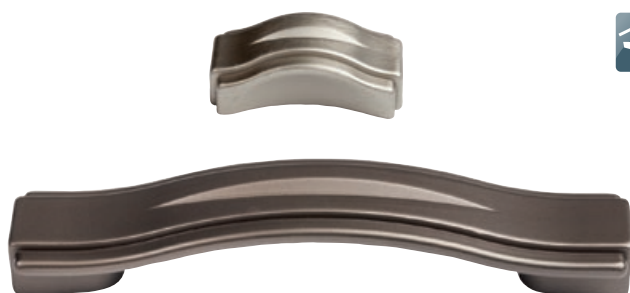

szín	hosszméret (mm)	furattáv (mm)	cikkszám
1. matt platina	50	32	10007552670
	136	96	10007552660
	171	128	10007552650
2. barna	50	32	10007552671
	136	96	10007552661
	171	128	10007552651
3. antik Firenze	136	96	10007551281
	171	128	10007551282

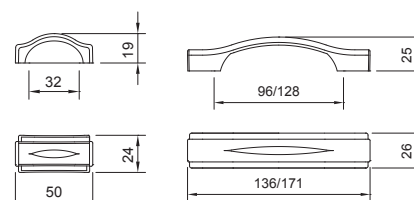

611.032 / 611.096 / 611.128 - fém



szín	hosszméret (mm)	furattáv (mm)	cikkszám
antik Firenze	47	32	10007551400
	122	96	10007551401
	153	128	10007551402

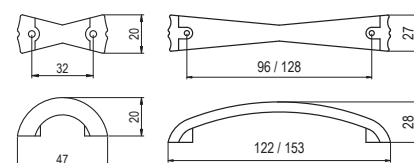

603.096 / 603.128 - fém



szín	hosszméret (mm)	furattáv (mm)	cikkszám
antik Firenze	102	96	10007551261
	134	128	10007551262

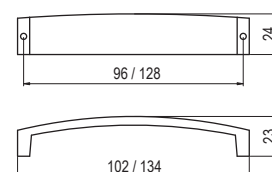

552.096 / 552.128 - fém



szín	hosszméret (mm)	furattáv (mm)	cikkszám
antik Firenze	112	96	10007551230
	144	128	10007551231

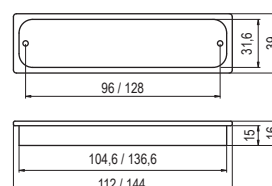

610.096 - fém



szín	cikkszám
antik Firenze	10007551380

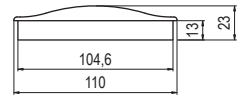
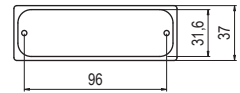

2023/30 - fém



szín	cikkszám
antik Firenze	10007551450

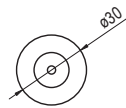

6017/0A - fém



szín	cikkszám
antik Firenze	10007551460

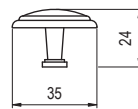
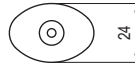

6022/30 - fém



szín	cikkszám
antik Firenze	10007551470

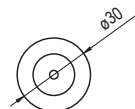

6200/32 - fém



6200/32	cikkszám
1. antik Firenze	10007551480
2. króm	10007551481

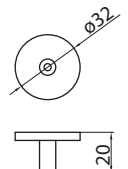



602.030 - fém



szín	cikkszám
antik Firenze	10007551250

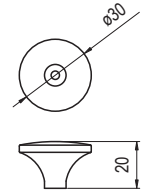

614.D64 / 614.S64 - fém



614.D64	cikkszám
1. króm	10007551410
2. antik Firenze	10007551420

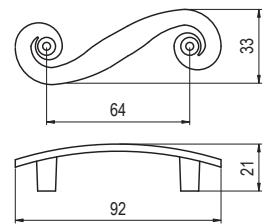

614.S64	cikkszám
1. króm	10007551415
2. antik Firenze	10007551425

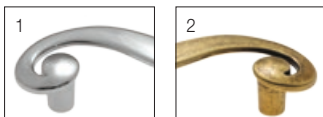
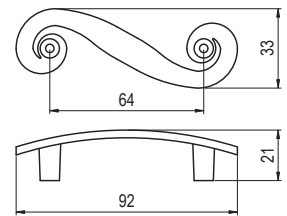

614.D96 / 614.S96 - fém



614.D96	cikkszám
1. króm	10007551411
2. antik Firenze	10007551421

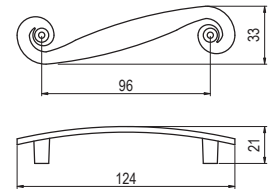

614.S96	cikkszám
1. króm	10007551416
2. antik Firenze	10007551426

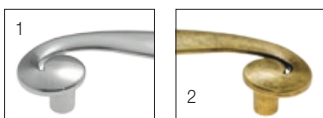
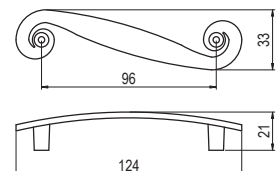

740 - fém



szín	hosszméret (mm)	furattáv (mm)	cikkszám
antik Firenze	gomb Ø31		10007552540
	110	96	10007552550
	142	128	10007552560

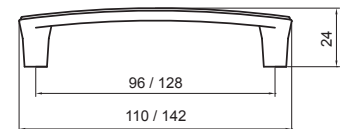
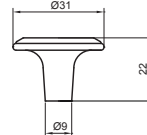
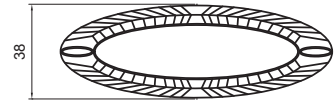

762- fém

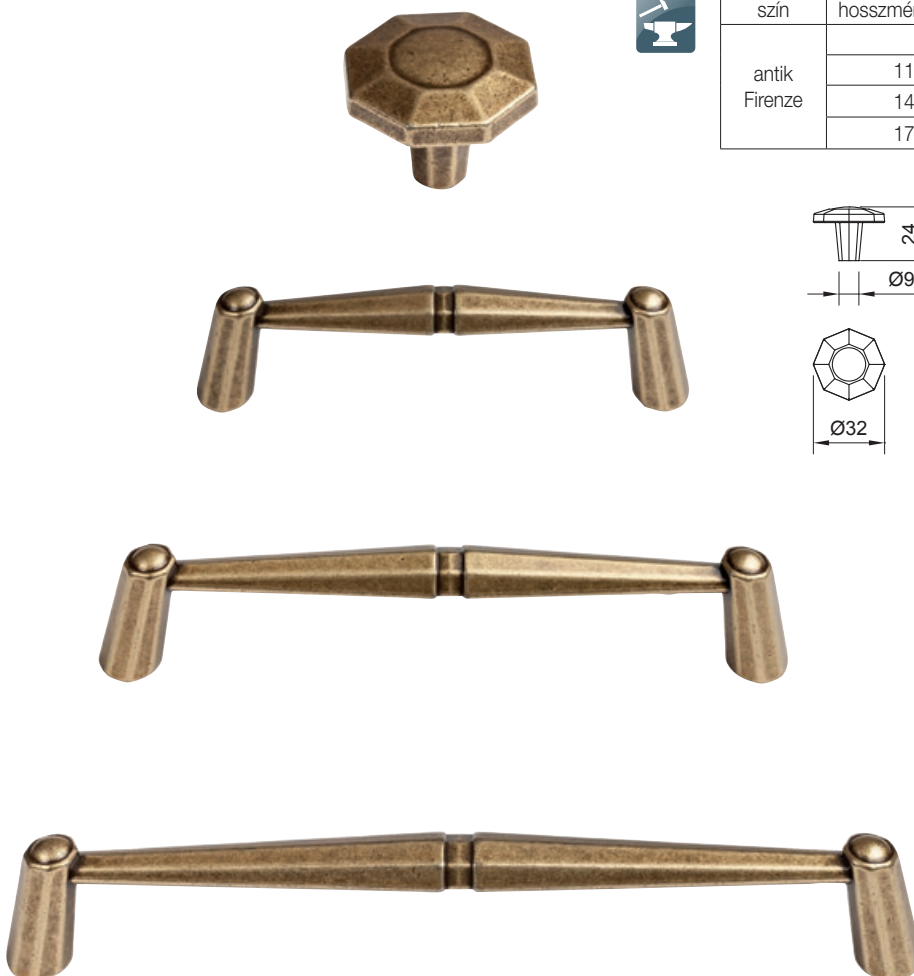

szín	hosszméret (mm)	furattáv (mm)	cikkszám
antik Firenze	gomb Ø32		10007552990
	110	96	10007552980
	142	128	10007552970
	175	160	10007552960

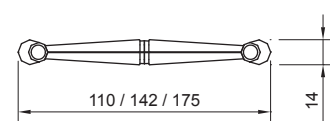
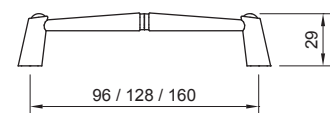
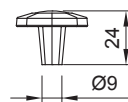

719.128 - fém



szín	cikkszám
1. antik Firenze	10007552430
2. arany antikolt krém	10007552431

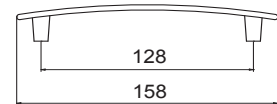

711.064 - fém



szín	cikkszám
1. antik Firenze	10007552440
2. arany antikolt krém	10007552441

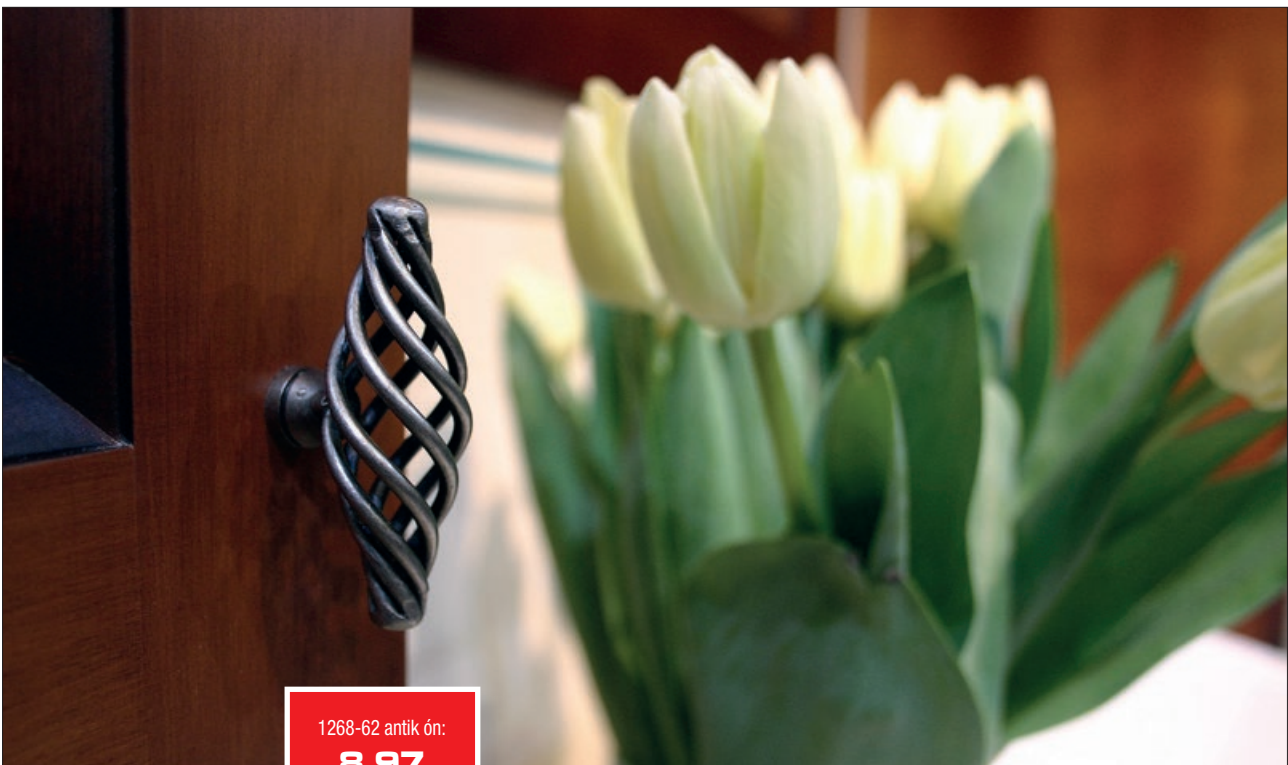
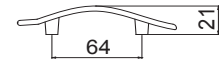
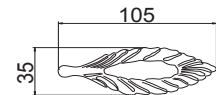

1268-62 antik ón:
8.97

706.035 - fém



szín	cikkszám
1. antik Firenze	10007552460
2. arany antikolt krém	10007552461
3. ezüst	10007552462



712.000 - fém



szín	cikkszám
1. antik Firenze	10007552450
2. arany antikolt krém	10007552451

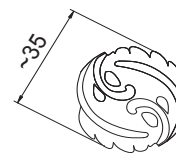
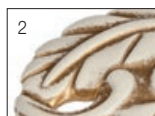

719.000 - fém



szín	cikkszám
1. antik Firenze	10007552420
2. arany antikolt krém	10007552421

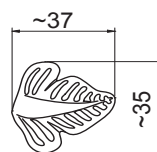

780- fém



szín	hosszméret (mm)	furattáv (mm)	cikkszám
1. antik Firenze	gomb 28x28		10007553025
	110	96	10007553020
	143	128	10007553010
	175	160	10007553000
2. antik fekete	gomb 28x28		10007553026
	110	96	10007553021
	143	128	10007553011
	175	160	10007553001

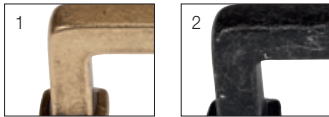
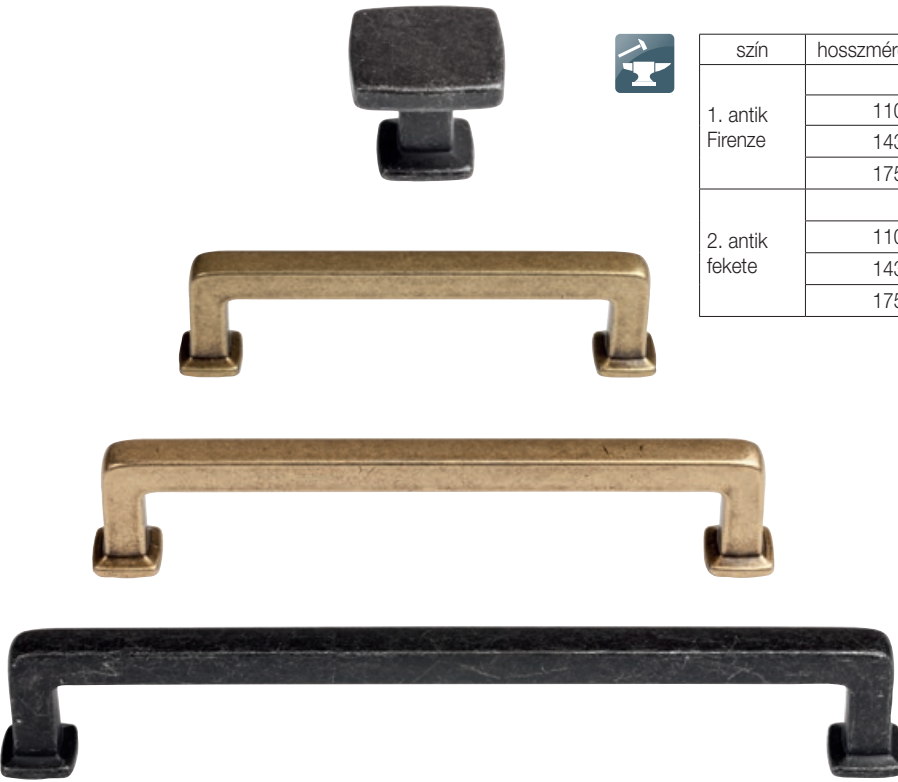
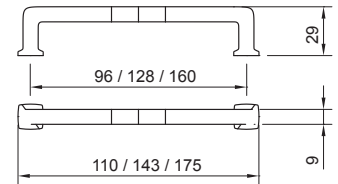
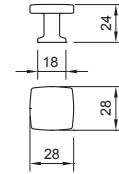

785 - fém



szín	hosszméret (mm)	furattáv (mm)	cikkszám
1. antik réz	gomb Ø15		10007552880
	110	96	10007552870
	143	128	10007552860
	175	160	10007552850
2. antik fekete	gomb Ø15		10007552881
	110	96	10007552871
	143	128	10007552861
	175	160	10007552851

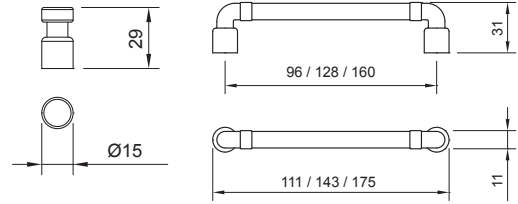

786 - fém

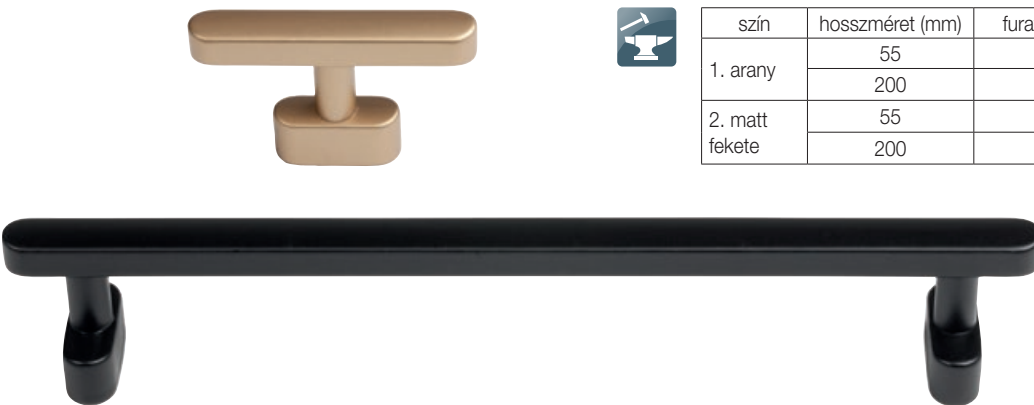

szín	hosszméret (mm)	furattáv (mm)	cikkszám
1. arany	55	16	10007552901
	200	160	10007552891
2. matt fekete	55	16	10007552900
	200	160	10007552890

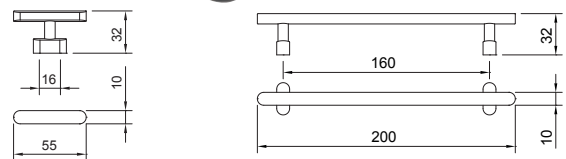



szín	hosszméret (mm)	furattáv (mm)	cikkszám
1. antik ón	gomb Ø32		10007552720
	114	96	10007552710
	147	128	10007552700
	179	160	10007552690
	211	192	10007552680
2. antik fekete	gomb Ø32		10007552721
	114	96	10007552711
	147	128	10007552701
	179	160	10007552691
	211	192	10007552681

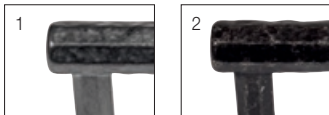
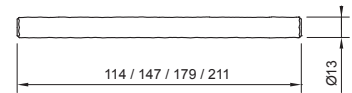
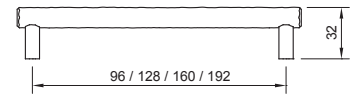
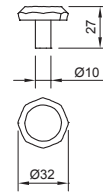

784 - fém



szín	hosszméret (mm)	furattáv (mm)	cikkszám
1. antik ón	gomb Ø17		10007552840
	107	96	10007552830
	139	128	10007552820
	170	160	10007552810
2. antik fekete	gomb Ø17		10007552841
	107	96	10007552831
	139	128	10007552821
	170	160	10007552811

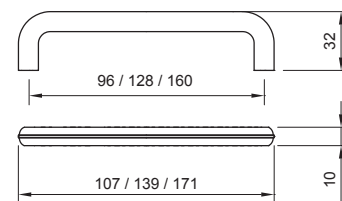
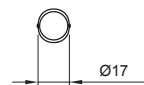
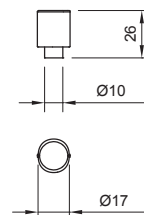

WMN776.160 - fém



szín	cikkszám
antik fekete	10007552780

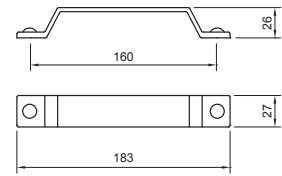

WCR100.019 díszpánt - fém

Legfeljebb 19 mm vastag ajtólapokhoz alkalmazható



szín	cikkszám
antik fekete	10007552790

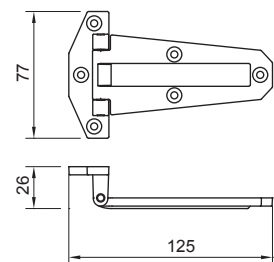

WMN777.032 - fém



szín	cikkszám
antik fekete	10007552800

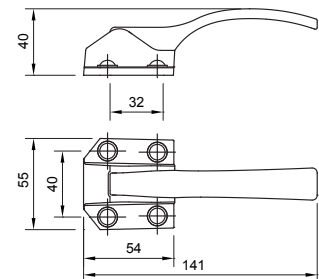

545-000 / 546-000 - fém



545-000	cikkszám
antik Firenze	10007551080

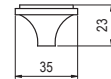
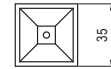

546-000	cikkszám
antik Firenze	10007551090

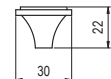
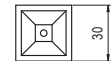

540-75 - fém

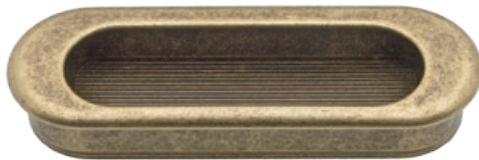

szín	cikkszám
antik Firenze	10007551020

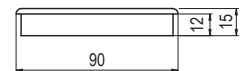
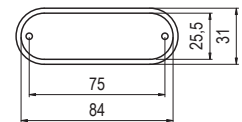

542-75 - fém



szín	cikkszám
antik Firenze	10007551030

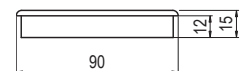
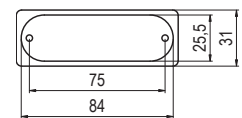

695 - fém



szín	furattáv (mm)	cikkszám
antik Firenze	gomb	10007551890
	96	10007551900
	128	10007551910

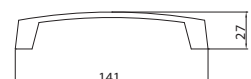
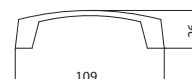
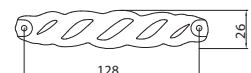
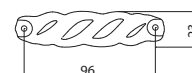
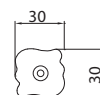

536-128 / 536-96 / 536-000 - fém



536-128	cikkszám
antik Firenze	10007551040

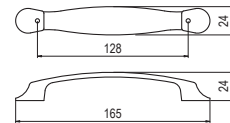

536-96	cikkszám
antik Firenze	10007551050

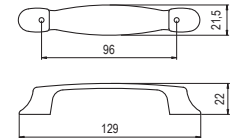

536-00	cikkszám
antik Firenze	10007551070

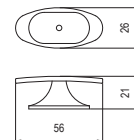

537-64 - fém



szín	cikkszám
antik Firenze	10007551060

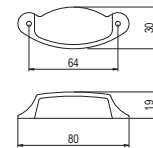

622.128 / 622.096 / 622.032 - fém



622.128	cikkszám
antik Firenze - jobbos	10007551600
antik Firenze - balos	10007551610

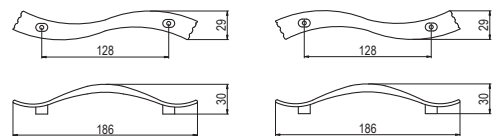

622.096	cikkszám
antik Firenze - jobbos	10007551620
antik Firenze - balos	10007551630

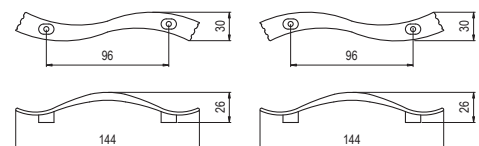

622.032	cikkszám
antik Firenze	10007551590

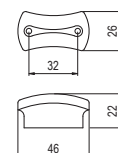

688 - fém



688.224	cikkszám
1. króm	10007551970
2. nikkel	10007551971

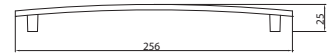
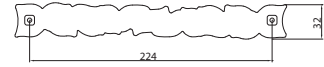

688.128	cikkszám
1. króm	10007551960
2. nikkel	10007551961

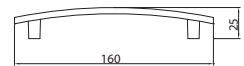
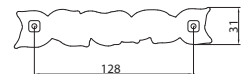

688.096	cikkszám
1. króm	10007551950
2. nikkel	10007551951

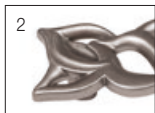
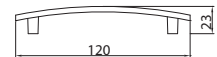
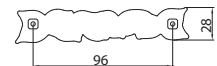

688.000	cikkszám
1. króm	10007551940
2. nikkel	10007551941

648.128 / 648.032 - fém



648.128	cikkszám
1. nikkel	10007551770
2. bronz	10007551771

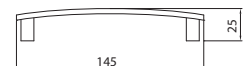

648.032	cikkszám
1. nikkel	10007551780
2. bronz	10007551781

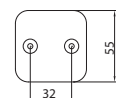

675 - fém



szín	furattáv (mm)	cikkszám
antik Firenze	192	10007551880
	96	10007551870

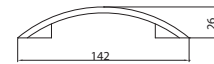
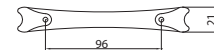
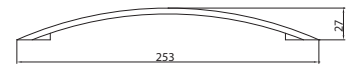
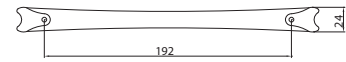

2028-25 / 2028-30 / 2028-35 - fém



2028-25	cikkszám
antik Firenze	10007551700

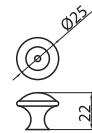

2028-30	cikkszám
antik Firenze	10007551701

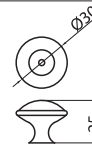

2028-35	cikkszám
antik Firenze	10007551702

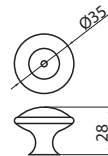

638-128 / 638-32 - fém



638-128	cikkszám
antik Firenze	10007551680

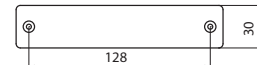

638-32	cikkszám
antik Firenze	10007551681

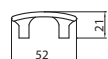
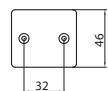

670-128 / 670-096 - fém



670-128	cikkszám
1. antik Firenze	10007551830
2. króm	10007551831

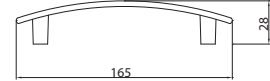
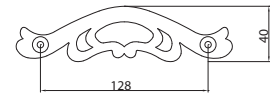

670-096	cikkszám
1. antik Firenze	10007551820
2. króm	10007551821

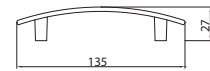
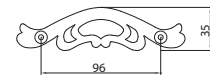

628-224 / 628-128 / 628-96 / 628-000 - fém



628-224	cikkszám
1. antik Firenze	10007551641
2. nikkél	10007551640

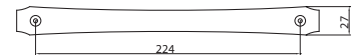

628-128	cikkszám
1. antik Firenze	10007551642

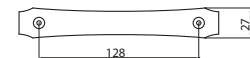

628-96	cikkszám
1. antik Firenze	10007551643
2. nikkél	10007551644

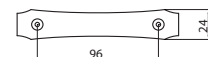

628-000	cikkszám
1. antik Firenze	10007551645



636-128 / 636-045 - fém



636-128	cikkszám
antik Firenze	10007551660

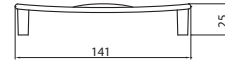
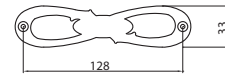

636-045	cikkszám
antik Firenze	10007551662



637-160- fém



szín	cikkszám
antik Firenze	10007551670

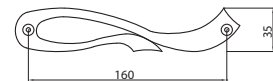

EM-603 - fém

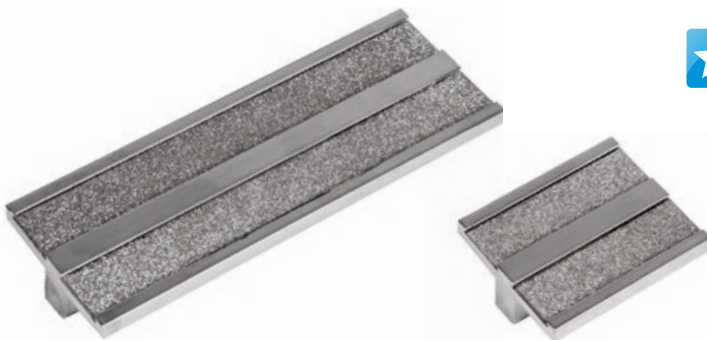

szín	furattáv (mm)	cikkszám
csillámos króm	32	10007700060
	96	10007700070

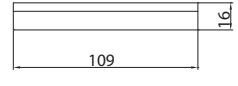
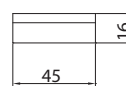
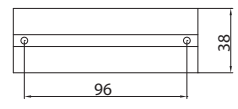
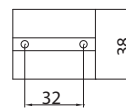

BR-170 - fém



szín	furattáv (mm)	cikkszám
antik	32	10007700100
	160	10007700110

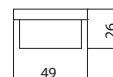
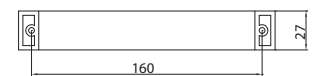
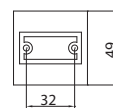

E040-096 - fém

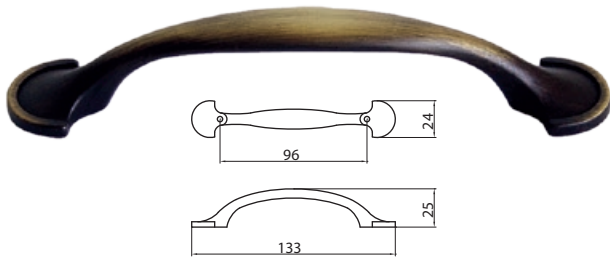

szín	cikkszám
antikolt	10007651004

E041-096 - fém

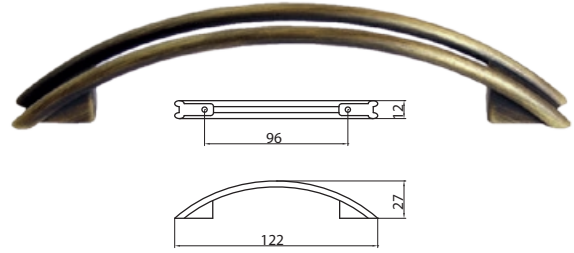

szín	cikkszám
antikolt	10007651014

E042-096 - fém

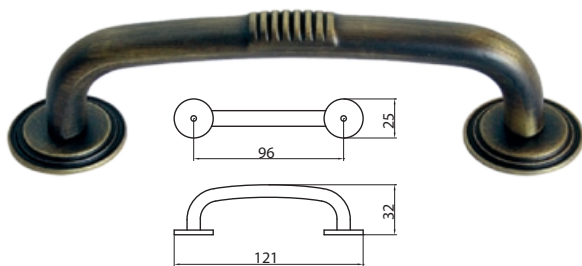

szín	cikkszám
antikolt	10007651024

E045-096 - fém

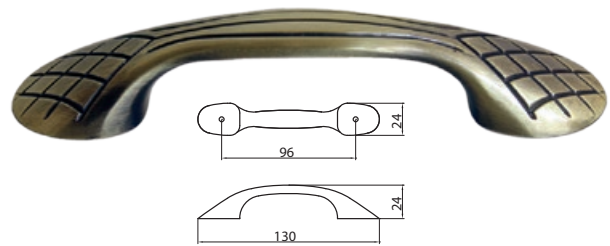

szín	cikkszám
fényes antikolt bronz	100076510745

E048-128 / E048-096 - fém



E048-128	cikkszám
fényes antikolt bronz	10007651125

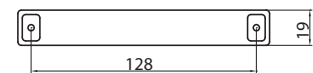

E048-096	cikkszám
fényes antikolt bronz	10007651115

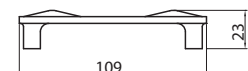
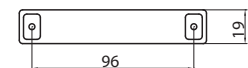

E077-128 - fém



szín	cikkszám
koptatott bronz	10007652500

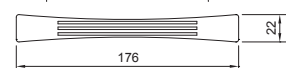
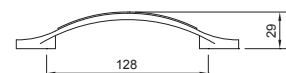

E044-128 / E044-096 / E044-000 - fém



E044-128	cikkszám
fényes antikolt bronz	10007651064

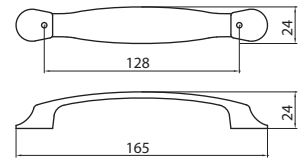

E044-096	cikkszám
fényes antikolt bronz	10007651054

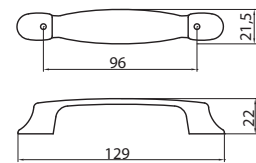

E044-000	cikkszám
fényes antikolt bronz	10007651044

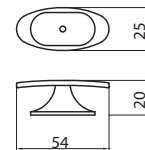

E046-128 / E046-096 - fém

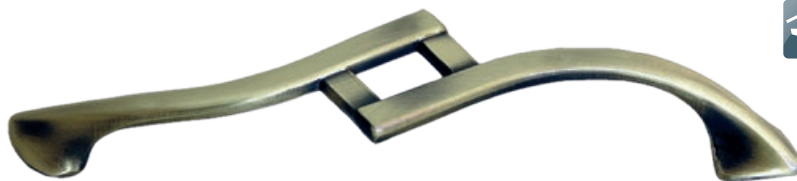

E046-128	cikkszám
fényes antikolt bronz	10007651094

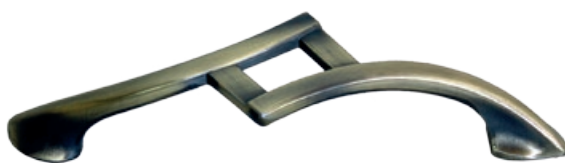
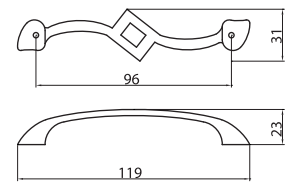

E046-096	cikkszám
fényes antikolt bronz	10007651084

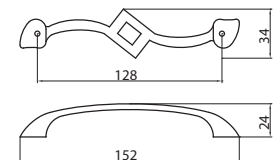

M01 - fém / porcelán

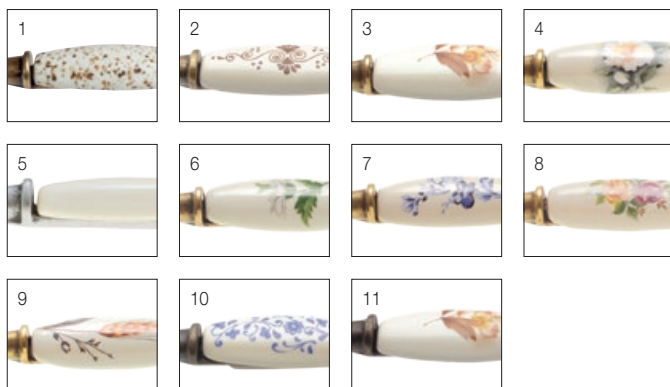
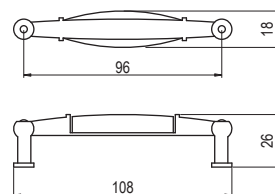

szín	cikkszám
1. antik Firenze - kőminta	10007550246
2. antik Firenze - barna motívum	10007550247
3. antikolt bronz - barna virág	10007550250
4. antikolt bronz - szürke virág	10007550251
5. ezüst - minta nélkül	10007550252
6. antikolt bronz - zöld virág	10007550253
7. antikolt bronz - kék virág	10007550254
8. antikolt bronz - színes virág	10007550256
9. antikolt bronz - búzakaralász	10007550257
10. country bronz - kék motívum	10007550258
11. country bronz - barna virág	10007550259

M10 - fém / porcelán

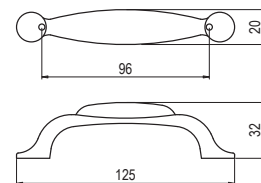

szín	cikkszám
1. country bronz - kék motívum	10007550308
2. country bronz - barna virág	10007550309
3. antikolt bronz - zöld virág	10007550310
4. antikolt bronz - kék virág	10007550311
5. antikolt bronz - szürke virág	10007550312
6. antikolt bronz - színes virág	10007550313
7. antikolt bronz - barna virág	10007550314
8. antikolt bronz - búzakaralász	10007550315
9. antik Firenze - kőminta	10007550316
10. antik Firenze - barna motívum	10007550317
11. antik Firenze - aranyfűst	10007550318
12. antik Firenze - bordó / aranykoszorú	10007550319

M17 - fém / porcelán

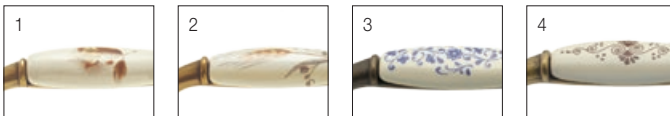
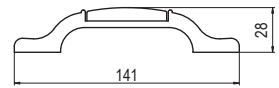
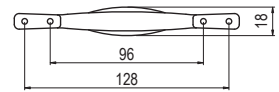

szín	cikkszám
1. antikolt bronz - barna virág	10007550330
2. antikolt bronz - búzagalász	10007550331
3. country bronz - kék motívum	10007550332
4. antik Firenze - barna motívum	10007550335

M22 - fém / porcelán



szín	cikkszám
antik Firenze - barna motívum	10007550490

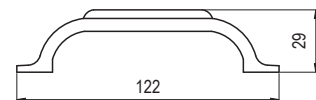
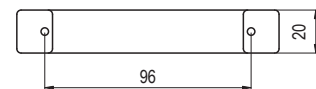

M50 - fém / porcelán

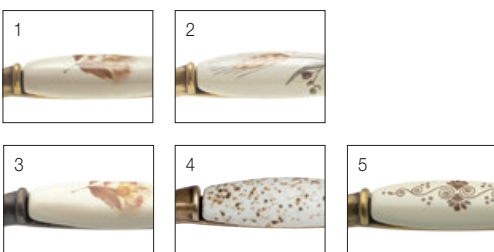
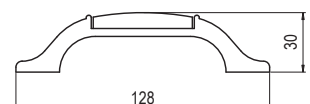
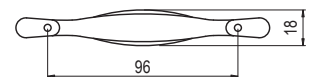

szín	cikkszám
1. antikolt bronz - barna virág	10007550340
2. antikolt bronz - búzagalász	10007550341
3. country bronz - barna virág	10007550343
4. antik Firenze - kőminta	10007550344
5. antik Firenze - barna motívum	10007550345

M70 - fém / porcelán



szín	cikkszám
1. antikolt krém - arany	10007552470
2. country bronz - barna	10007552480
3. antik Firenze - arany	10007552490

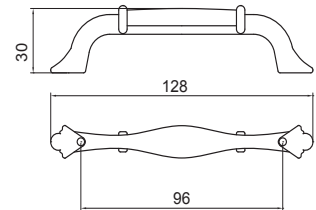

M94 - fém

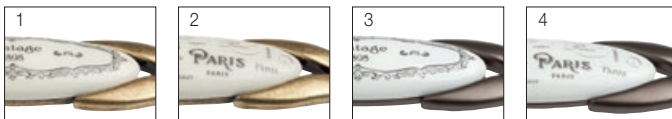

szín	cikkszám
1. antik Firenze - elefántcsont - Vintage	10007553040
2. antik Firenze - fehér - Paris	10007553041
3. barna - elefántcsont - Vintage	10007553042
4. barna - fehér - Paris	10007553043

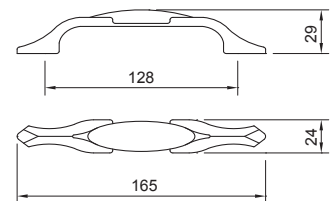

M95 - fém



szín	cikkszám
1. antik Firenze - elefántcsont - Vintage	10007553050
2. antik Firenze - fehér - Paris	10007553051
3. barna - elefántcsont - Vintage	10007553052
4. barna - fehér - Paris	10007553053

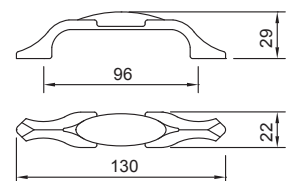

P01 - fém / porcelán



szín	cikkszám
1. antikolt bronz - barna virág	10007550260
2. antikolt bronz - színes virág	10007550264
3. antikolt bronz - búzagalász	10007550265

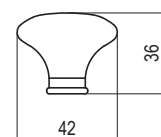
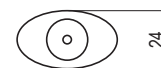

P03 - fém / porcelán



szín	cikkszám
1. antikolt bronz - barna virág	10007550270
2. antikolt bronz - zöld virág	10007550271
3. antikolt bronz - kék virág	10007550272
4. antikolt bronz - színes virág	10007550274
5. antikolt bronz - búzagalász	10007550275

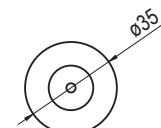

P04 - fém / porcelán



szín	cikkszám
1. antikolt bronz - zöld virág	10007550360
2. antikolt bronz - kék virág	10007550361
3. antikolt bronz - barna virág	10007550364
4. antikolt bronz - búzagalász	10007550365

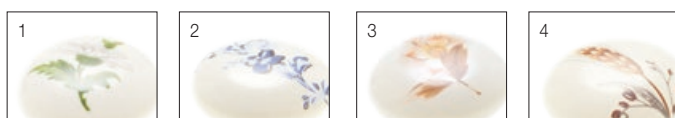
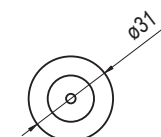

P07 - fém / porcelán



szín	cikkszám
1. country bronz - kék motívum	10007550278
2. country bronz - barna virág	10007550279
3. antikolt bronz - barna virág	10007550280
4. antikolt bronz - zöld virág	10007550281
5. antikolt bronz - kék virág	10007550282
6. antikolt bronz - szürke virág	10007550283
7. antikolt bronz - színes virág	10007550284
8. antikolt bronz - búzalkalász	10007550285
9. antik Firenze - kőminta	10007550286
10. antik Firenze - barna motívum	10007550287
11. antik Firenze - aranyfüst	10007550288
12. antik Firenze - bordó / aranykoszorú	10007550289

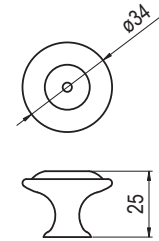

P08 - fém / porcelán



szín	cikkszám
1. antikolt bronz - barna virág	10007550290
2. antikolt bronz - zöld virág	10007550291
3. antikolt bronz - kék virág	10007550292
4. antikolt bronz - szürke virág	10007550293
5. antikolt bronz - színes virág	10007550294
6. antikolt bronz - búzalkalász	10007550295

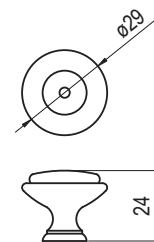

P18 - fém / porcelán



szín	cikkszám
country bronz - barna virág	10007550440

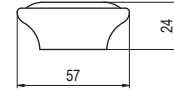
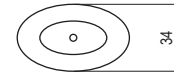

P23 - fém / porcelán



szín	cikkszám
1. antikolt bronz - kőminta	10007550435
2. antikolt bronz - minta nélkül	10007550436

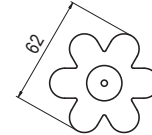

P77 - fém



szín	cikkszám
1. antik Firenze - elefántcsont - Vintage	10007553030
2. antik Firenze - fehér - Paris	10007553031
3. barna - elefántcsont - Vintage	10007553032
4. barna - fehér - Paris	10007553033

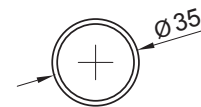

P88 - fém / porcelán



szín	cikkszám
1. antikolt krém - arany	10007552471
2. country bronz - barna	10007552481
3. antik Firenze - arany	10007552491

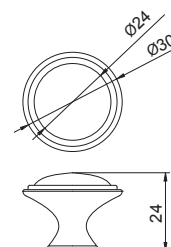

110-32 - fém / porcelán



szín	cikkszám
1. antikolt bronz - minta nélkül	10007550020
2. antikolt bronz - barna virág	10007550021

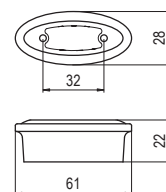

120-128 - fém / porcelán

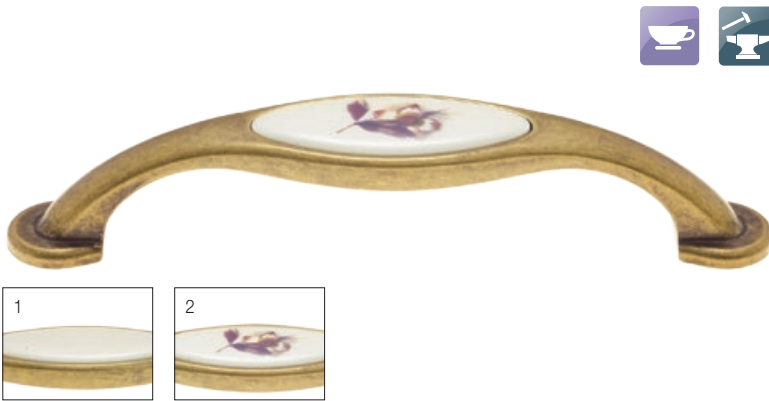

szín	cikkszám
1. antikolt bronz - minta nélkül	10007550030
2. antikolt bronz - barna virág	10007550031

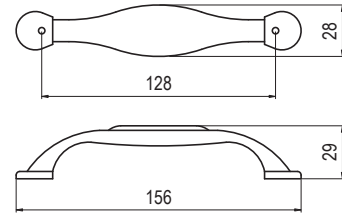

M55 - fém / porcelán



szín	cikkszám
antik Firenze - beige	10007551540

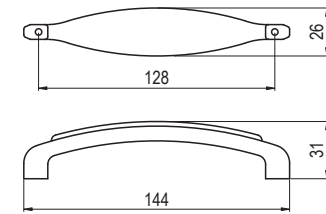

E038-96 - fém / porcelán



szín	cikkszám
1. antikolt bronz - barna virág	10007652000
2. antikolt bronz - szürke virág	10007652001
3. antikolt bronz - búzagalász	10007652002

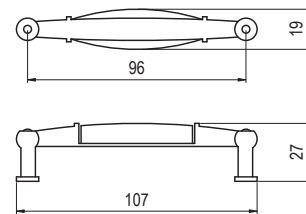

E039-26 - porcelán



szín	cikkszám
1. barna virág	10007652020
2. szürke virág	10007652021
3. búzagalász	10007652022

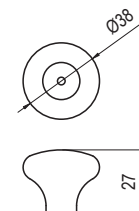

E050-96 - fém / porcelán



szín	cikkszám
1. antikolt bronz - barna virág	10007652030
2. antikolt bronz - szürke virág	10007652031
3. antikolt bronz - búzagalász	10007652032

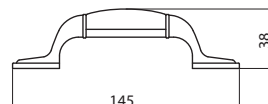
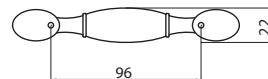

E051-96 - fém / porcelán



szín	cikkszám
1. antikolt bronz - barna virág	10007652040
2. antikolt bronz - szürke virág	10007652041
3. antikolt bronz - búzagalász	10007652042

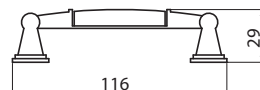
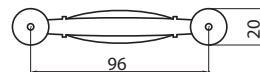

E052-96 - fém / porcelán



szín	cikkszám
1. antikolt bronz - barna virág	10007652050
2. antikolt bronz - szürke virág	10007652051
3. antikolt bronz - búzagalász	10007652052

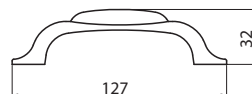
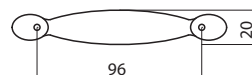

E053-33 - fém / porcelán



szín	cikkszám
1. antikolt bronz - barna virág	10007652060
2. antikolt bronz - szürke virág	10007652061
3. antikolt bronz - búzagalász	10007652062

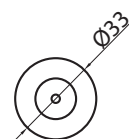

C2027 - fém / porcelán



szín	cikkszám
matt bronz - arany virág	10007500230

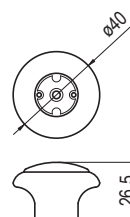

C2028 - fém / porcelán, - fém



szín	cikkszám
1. matt bronz - arany virág	10007500240
2. antikolt bronz - kék virág	10007500241
3. galvanizált nikkell	10007500245

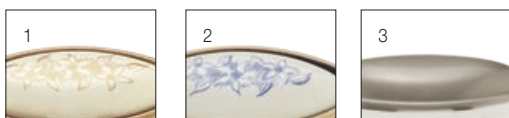
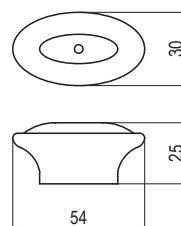

C1017 - fém / porcelán



szín	cikkszám
1. matt bronz - arany virág	10007500220
2. antikolt bronz - kék virág	10007500221
3. antikolt ezüst- kék virág	10007500222

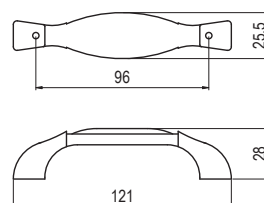



1896-30 - fém / műanyag



szín	cikkszám
1. króm - fehér	10007304935
2. antikolt bronz - beige	10007304936

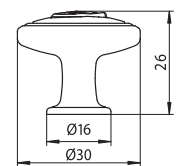

1897-32 - fém / műanyag



szín	cikkszám
1. króm - fehér	10007304940
2. antikolt bronz - beige	10007304941

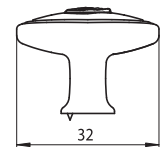
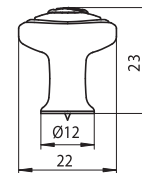

1898-106 / 1898-138 - - fém / műanyag



1898-106	cikkszám
1. króm - fehér	10007304950
2. antikolt bronz - beige	10007304951

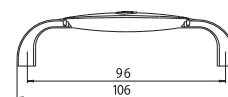

1898-138	cikkszám
2. antikolt bronz - beige	10007304956

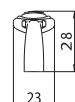
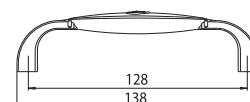

1973-106 / 1973-138 - fém / műanyag



1973-106	cikkszám
antikolt bronz - beige	10007305050

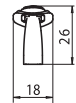
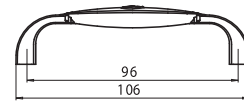

1973-138	cikkszám
antikolt bronz - beige	10007305055

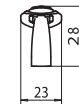
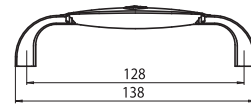

1889-67 - fém / műanyag



szín	cikkszám
antikolt bronz - minta nélkül	10007306310

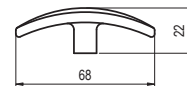

1881-130 - fém / műanyag



szín	cikkszám
antikolt bronz - minta nélkül	10007306320

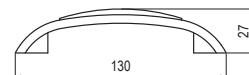
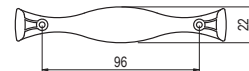

1700-29 - fém / porcelán

SIRO®
www.siro.cc

szín	cikkszám
1. antik bronz - tört porcelán	10007306330
2. antik bronz - minta nélkül	10007306331

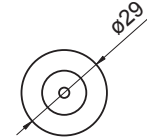

1699-107 - fém / porcelán



szín	cikkszám
1. antik bronz - tört porcelán	10007306340
2. antik bronz - minta nélkül	10007306341

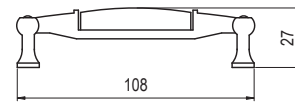
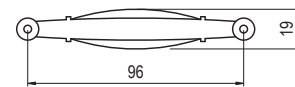

SP1-33 - porcelán



szín	cikkszám
fehér - arany	10007421700

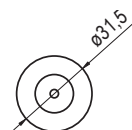

SP12-35 - porcelán



szín	cikkszám
fehér	10007421600

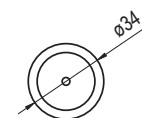

P10 - fém / porcelán



szín	cikkszám
1. törtfehér - réz	10007550372
2. fehér - réz	10007550373

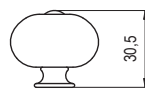

T 402-38 - porcelán



szín	cikkszám
fehér - arany	10007608800

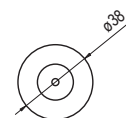

T 404-35 - porcelán



szín	cikkszám
fehér	10007609000

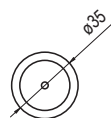

1882-56 - fém

SIRO®
www.siro.cc

szín	cikkszám
antik ezüst	10007250440



1884-48 - fém



szín	cikkszám
antik ezüst	10007250460



1885-56 - fém



szín	cikkszám
antik ezüst	10007250470

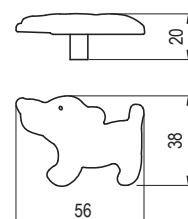

1886-36 - fém



szín	cikkszám
antik ezüst	10007250480

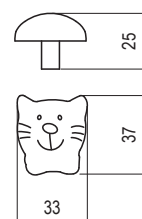

1883-109 - fém



szín	cikkszám
antik ezüst	10007250450

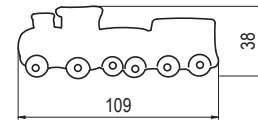
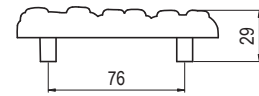

1887-41 - fém



szín	cikkszám
antik ezüst	10007250491

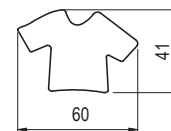

1888-40 - fém



szín	cikkszám
antik ezüst	10007250501

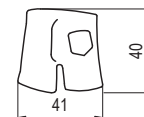
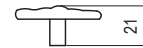

H147-47 - gumi



szín	cikkszám
piros	10007250320

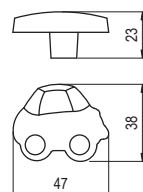

SIRO®
www.siro.cc

H148-40 - gumi



szín	cikkszám
fekete - fehér	10007250330

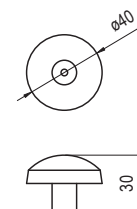

H150-53 - gumi



szín	cikkszám
narancs	10007250350

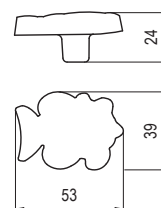

H157-50 - gumi



szín	cikkszám
színes	10007250410

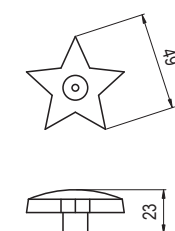

H158-51 - gumi

SIRO®
www.siro.cc

szín	cikkszám
szürke	10007250420

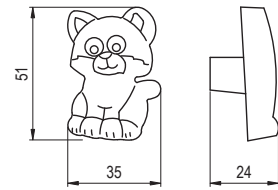

H159-50 - gumi



szín	cikkszám
zöld	10007250430

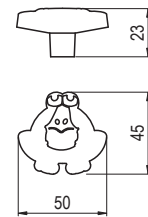

H152-44 - gumi



szín	cikkszám
színes	10007250360

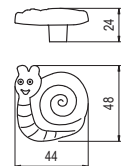

H149-44 - gumi

SIRO®
www.siro.cc

szín	cikkszám
sárga	10007250340

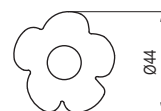

H149-44 - gumi



szín	cikkszám
rózsaszín	10007250342

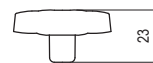

H149-44 - gumi



szín	cikkszám
kék	10007250341



H 039-44 - műanyag

SIRO[®]
www.siro.cc

szín	cikkszám
piros	10007250050

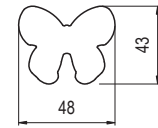

H 040-40 - műanyag



szín	cikkszám
kék	10007250060

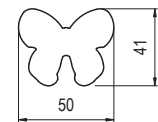

H 041-42 - műanyag



szín	cikkszám
narancs	10007250070

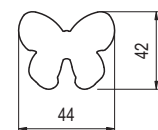

H 049-41 - műanyag

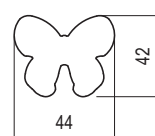

szín	cikkszám
sárga	10007250090

H 022-56 - műanyag

SIRO®
www.siro.cc

szín	cikkszám
barna	10007250010

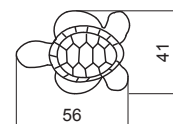

H 023-55 - műanyag



szín	cikkszám
barna	10007250013



01022-153 - műanyag

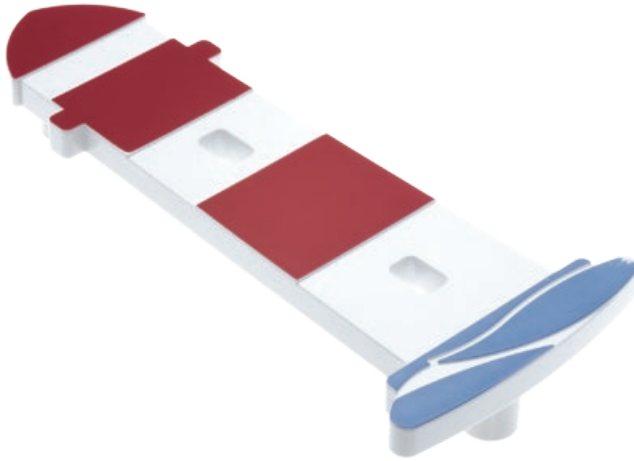

szín	cikkszám
színes	10007250510

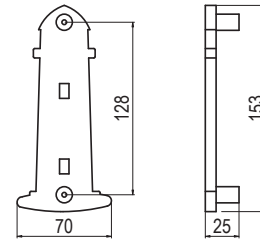

01023-34 - műanyag



szín	cikkszám
színes	10007250520

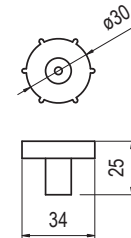

8004-164 - műanyag



minta	cikkszám
1. vonat	10007432500
2. tündér	10007432501
3. autó	10007432502

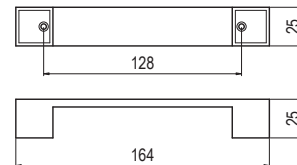

8045-36 - műanyag



minta	cikkszám
1. tündér	10007432521
2. autó	10007432522
3. kacsa	10007432523
4. bárány	10007432525
5. cica	10007432526
6. egér	10007432531

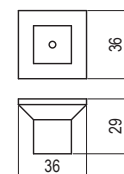

T-513 - gumi



szín	cikkszám
fekete-fehér	10007611130

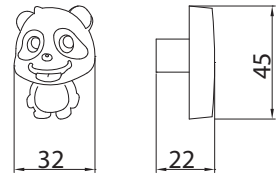

T-509 - gumi



szín	cikkszám
szürke	10007611080

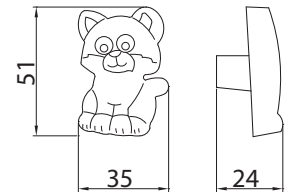

T-514 - gumi



szín	cikkszám
szürke	10007611140

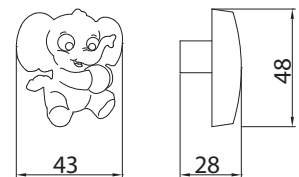

T-510 - gumi



szín	cikkszám
színes	10007611090

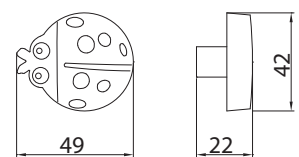

T-504 - gumi



szín	cikkszám
színes	10007611030

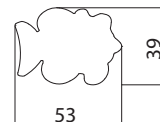

T-508 - gumi



szín	cikkszám
zöld	10007611070

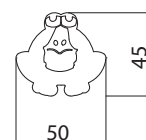

T-505 - gumi



szín	cikkszám
színes	10007611040



T-507 - gumi



szín	cikkszám
piros-fehér	10007611060

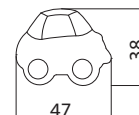

T-511 - gumi



szín	cikkszám
1. kék	10007611110
2. sárga	10007611100

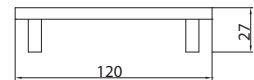
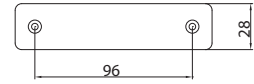
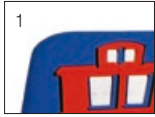

T-506 - gumi



szín	cikkszám
fekete-fehér	10007611050

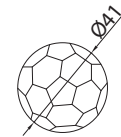

T-500 - gumi



szín	cikkszám
1. pink	10007611000
2. sárga	10007611002
3. kék	10007611001

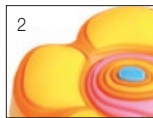
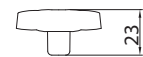

T-501 - gumi



szín	cikkszám
színes	10007611010

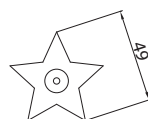

T-502 - gumi



szín	cikkszám
színes	10007611020

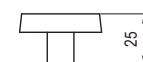
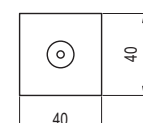

426 X - műanyag

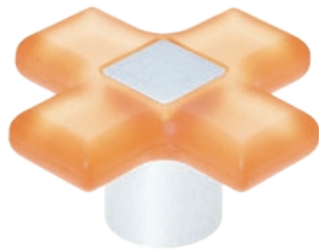

szín	cikkszám
1. kék áttetsző	10007808000
2. narancs áttetsző	10007808002
3. piros áttetsző	10007808003

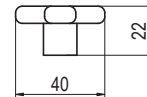
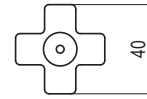

96/M - műanyag



szín	cikkszám
piros áttetsző	10007808110

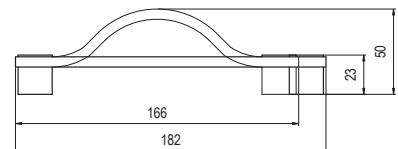
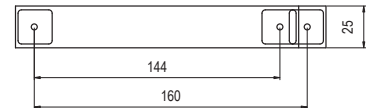

8085-32 - műanyag



szín	cikkszám
1. rózsaszín - matt króm	10007432970
2. kék króm	10007432971

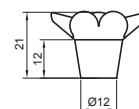
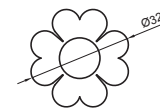

8116-50 - műanyag



szín	cikkszám
1. narancs áttetsző - alumínium	10007432320
2. zöld áttetsző - alumínium	10007432321
3. kék áttetsző - alumínium	10007432322
4. rózsaszín áttetsző - alumínium	10007432323

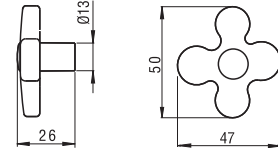
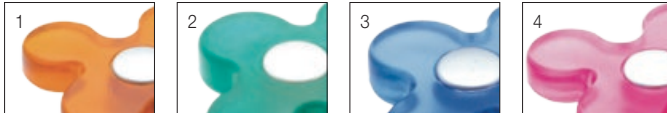

8117-34 - műanyag



szín	cikkszám
1. világoszöld áttetsző	10007432330
2. világos rózsaszín áttetsző	10007432331
3. piros áttetsző	10007432332
4. világoskék áttetsző	10007432333

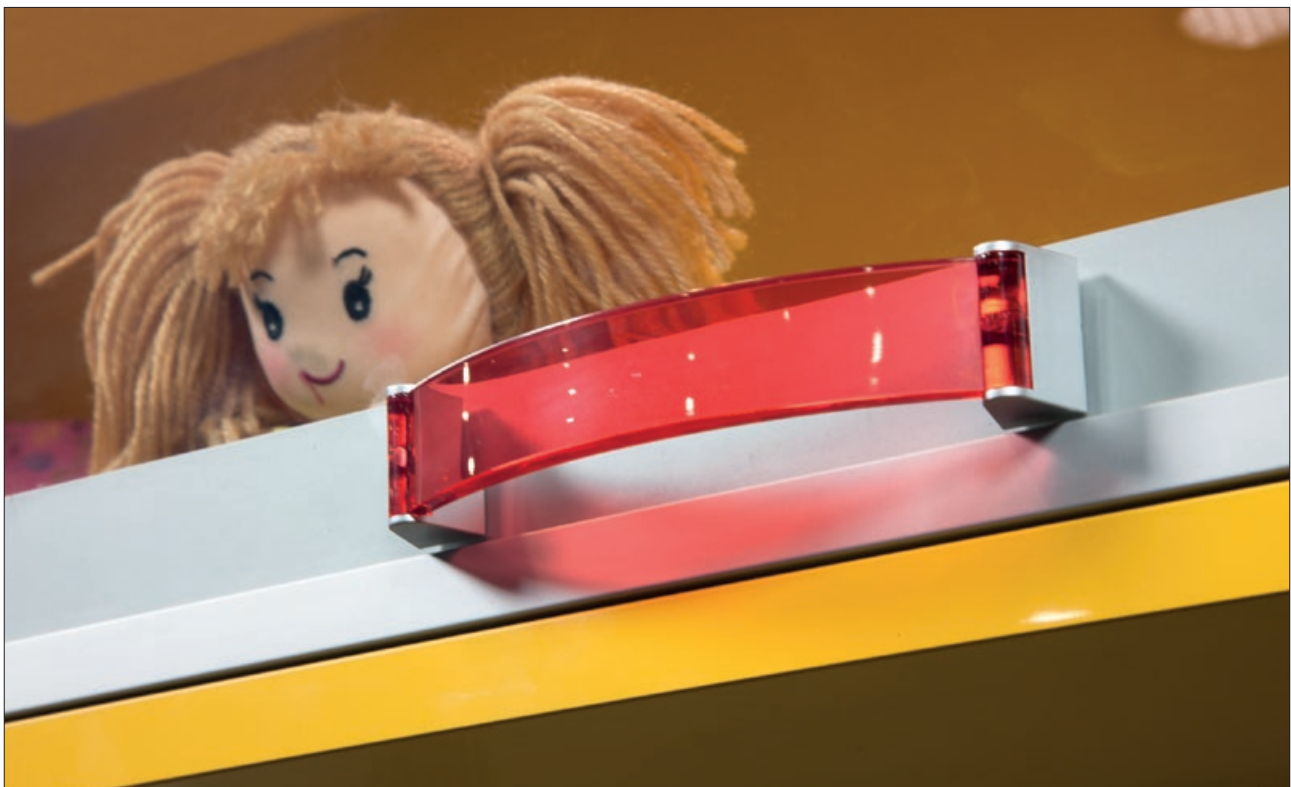
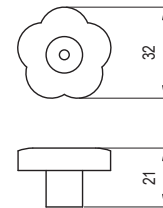

0089-144 - műanyag



szín	cikkszám
1. áttetsző - alumínium	10007432890
2. narancs - alumínium	10007432892
3. kék - alumínium	10007432894
4. piros - alumínium	10007432895
5. zöld - alumínium	10007432896
6. rózsaszín - alumínium	10007432897

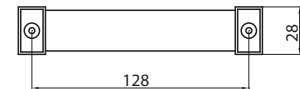
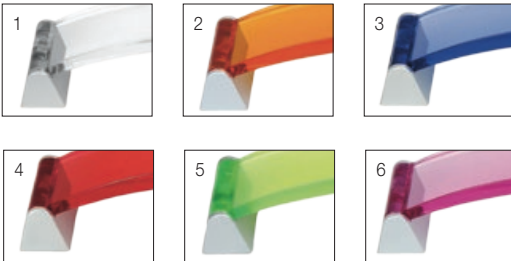

8178-137 - műanyag



szín	cikkszám
1. fehér	10007432930
2. fekete	10007432931
3. narancs	10007432932
4. sárga	10007432933
5. kék	10007432934
6. piros	10007432935
7. zöld	10007432936
8. rózsaszín	10007432937

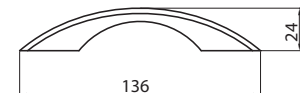
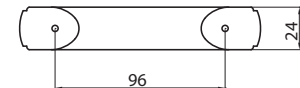
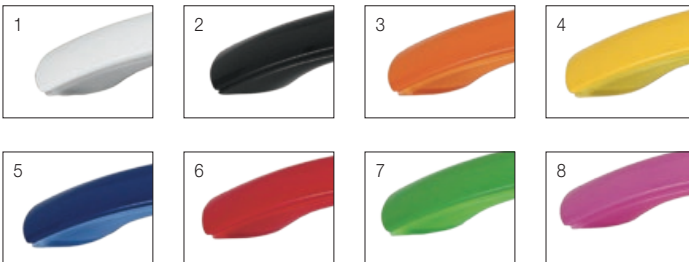

8200-82 - műanyag



szín	cikkszám
1. fehér	10007432940
2. fekete	10007432941
3. sárga	10007432943
4. piros	10007432945
5. zöld	10007432946
6. rózsaszín	10007432947

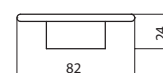
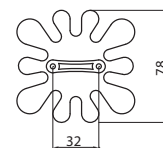

8119-126 - műanyag

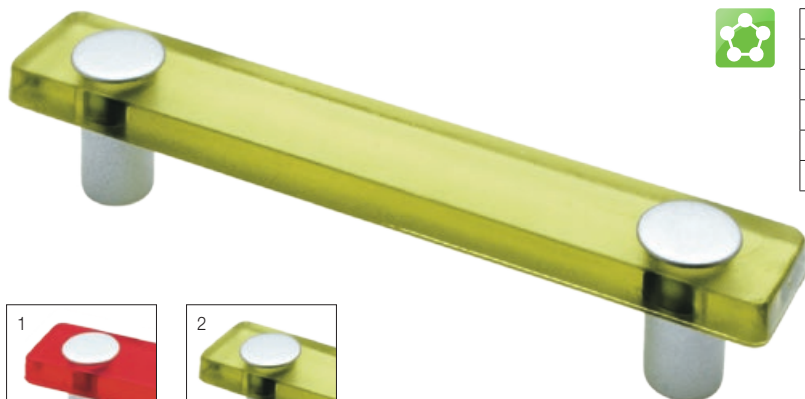
S I R O[®]
www.siro.cc

szín	cikkszám
1. piros áttetsző - alumínium	10007432350
2. olívazöld áttetsző - alumínium	10007432351
3. áttetsző - alumínium	10007432352
4. narancs áttetsző - alumínium	10007432353
5. világoskék áttetsző - alumínium	10007432354

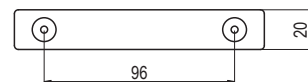
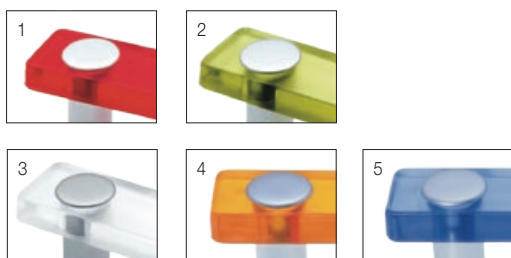

8118-30 - műanyag



szín	cikkszám
1. piros áttetsző - alumínium	10007432340
2. olívazöld áttetsző - alumínium	10007432341
3. áttetsző - alumínium	10007432342
4. narancs áttetsző - alumínium	10007432343
5. világoskék áttetsző - alumínium	10007432344

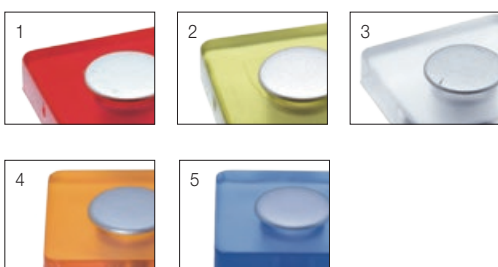
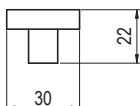
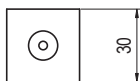

8095-148 - műanyag



szín	cikkszám
króm - fekete	10007432870

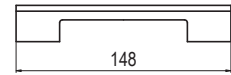
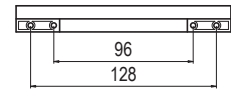

306 - műanyag



szín	cikkszám
1. áttetsző-fehér	10007808140
2. áttetsző-fekete	10007808141

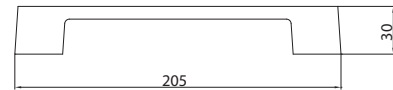
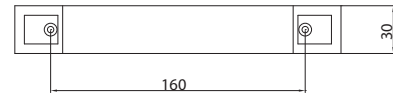

37B - műanyag



szín	cikkszám
1. áttetsző-króm	10007808130
2. áttetsző fekete-króm	10007808131

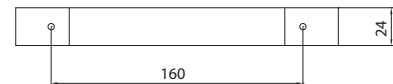

8014-184 - műanyag



szín	cikkszám
fekete bőrhatású	10007432162

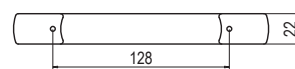

8059-176 - műanyag



szín	cikkszám
barna bőrhatású	10007432141

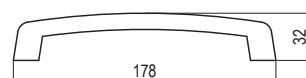
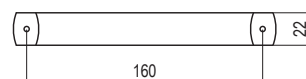

8151-60 - műanyag



szín	cikkszám
1. króm - beige bőrhatású	10007432761
2. króm - barna bőrhatású	10007432762
3. króm - wenge	10007432763

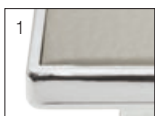
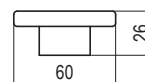
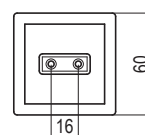

8109-180 - műanyag



szín	cikkszám
wenge - matt króm	10007432610

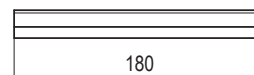
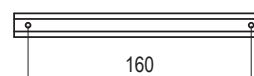

8104-40 - műanyag



szín	cikkszám
wenge - alumínium	10007432390



8103-136 - műanyag



szín	cikkszám
wenge - alumínium	10007432400

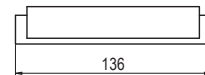
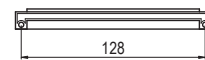

8086-44 / 8086-172 - műanyag



8086-44	cikkszám
wenge - alumínium	10007432360

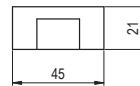
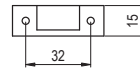

8086-172	cikkszám
wenge - alumínium	10007432370

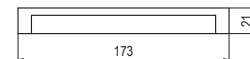
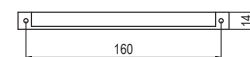

8147-138 / 8147-202 - műanyag

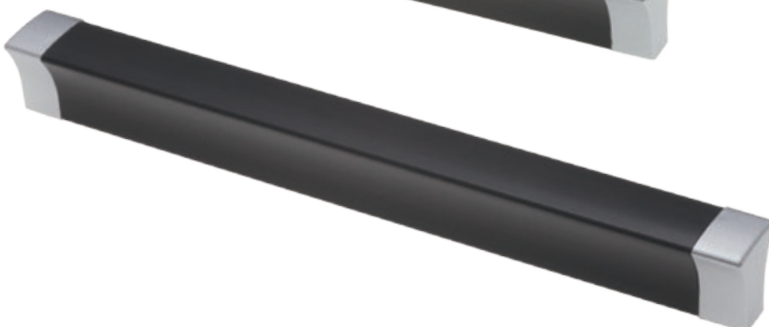

8147-138	cikkszám
wenge - alumínium	10007432750

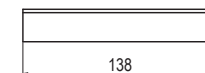
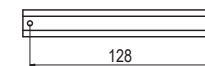

8147-202	cikkszám
wenge - alumínium	10007432751

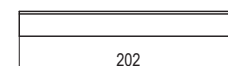
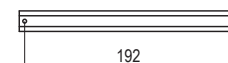

8105-144 - műanyag



szín	cikkszám
wenge - matt króm	10007432380

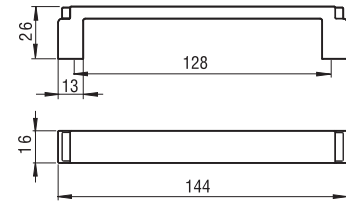
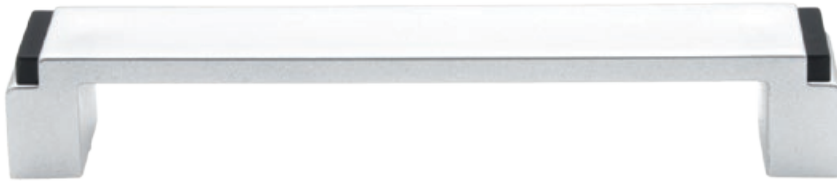

8137-137 - műanyag



szín	cikkszám
1. matt nikkell	10007432700
2. matt króm	10007432701
3. fekete	10007432702
4. fehér	10007432703
5. króm	10007434050
6. acél	10007434051
7. fekete, réz szegélylél	10007432704
8. fekete, alumínium szegélylél	10007432705
9. fekete bazalt	10007432706
10. antik acél	10007432707

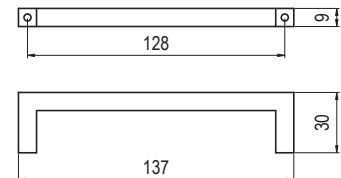
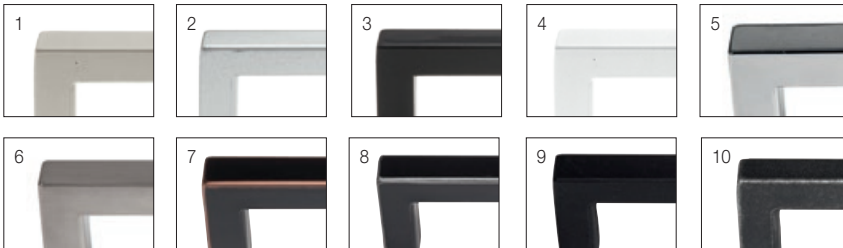

0618-64 - műanyag



szín	cikkszám
1. fekete	10007408500
2. fehér	10007408600

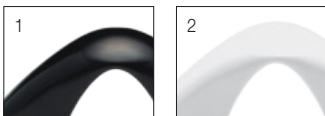
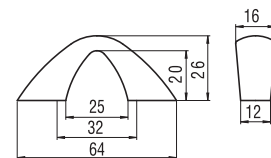

8271-186 - műanyag



szín	cikkszám
1. fekete, réz szegéllyel	10007434120
2. fekete, alumínium szegéllyel	10007434121
3. fekete bazalt	10007434122

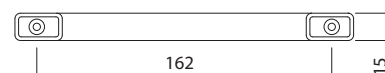

8265-48 - műanyag



szín	cikkszám
1. fekete titánium	10007434130
2. barna titánium	10007434131

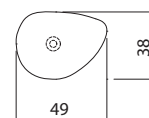
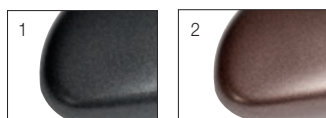

8243-170 - műanyag



szín	cikkszám
1. króm	10007434020
2. acél	10007434021

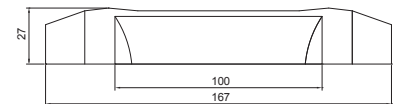

8241-206 - műanyag



szín	cikkszám
1. króm	10007434030
2. acél	10007434031

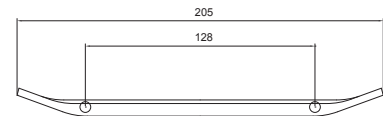

8026-24 - műanyag



szín	cikkszám
1. króm	10007434040
2. acél	10007434041

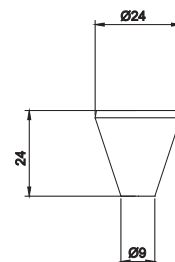

8209-72 - műanyag

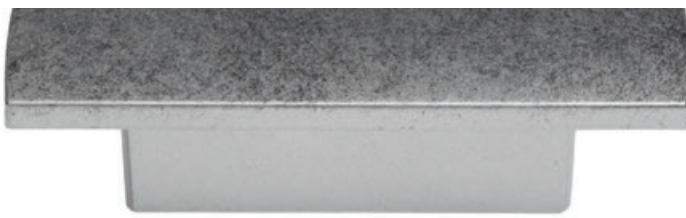

szín	cikkszám
1. kalapács acél	10007434070
2. titánium	10007434071

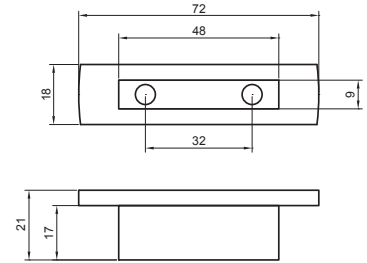
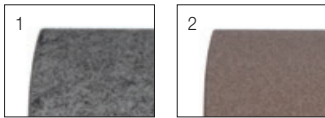

0104-60 - műanyag



szín	cikkszám
1. kalapács acél	10007434080
2. titánium	10007434081

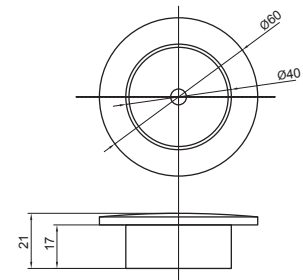

8257-58 - műanyag



szín	cikkszám
1. fehér	10007434090
2. kék	10007434091
3. rózsaszín	10007434092

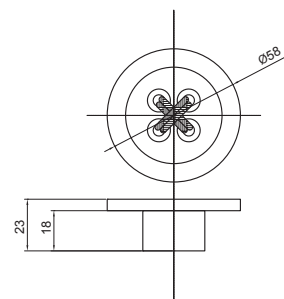

8246-200 - műanyag



szín	cikkszám
1. króm	10007434100
2. nikkell	10007434101
3. vörösréz	10007434102
3. titánium	10007434103

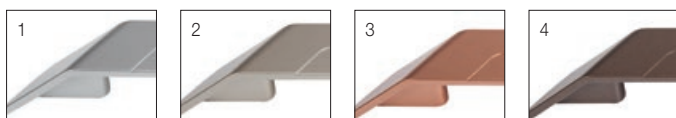
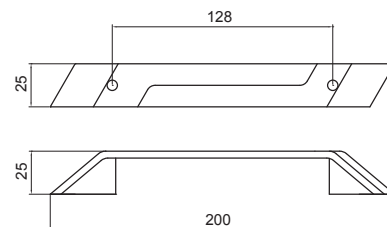

8076-15 - műanyag



szín	cikkszám
1. matt nikkell	10007432130
2. matt króm	10007432131

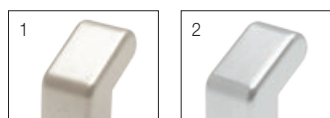
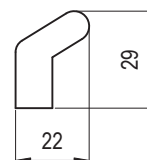

8066-36 - műanyag



szín	cikkszám
1. matt nikkell	10007432170
2. matt króm	10007432171

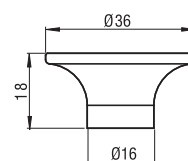



8006-25 - műanyag



szín	cikkszám
1. matt nikkel	10007432110
2. matt króm	10007432111
3. vörösrez	10007432112

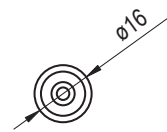

8113-42 - műanyag

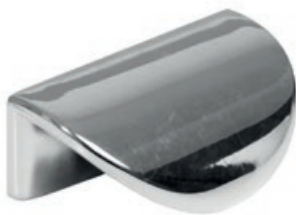

szín	cikkszám
króm	10007434000

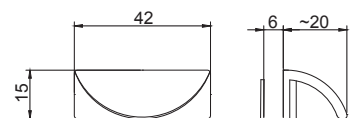

8004-164 - műanyag



szín	cikkszám
1. matt króm	10007432261
2. fekete, réz szegélyyel	10007434110
3. fekete, alumínium szegélyyel	10007434111
4. fekete bazalt	10007434112

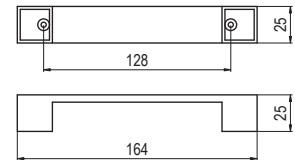
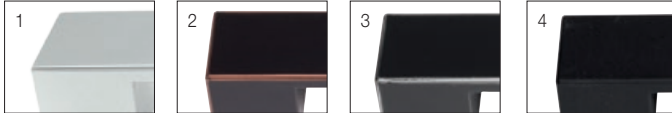

8015-25 - műanyag



szín	cikkszám
1. matt nikkél	10007432090
2. matt króm	10007432091

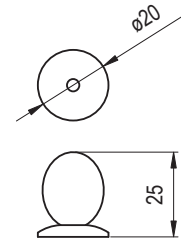

8059-176 / 8059-240 - műanyag



8059-176	cikkszám
1. matt króm	10007432140
2. fekete, réz szegélyyel	10007432142
3. fekete, alumínium szegélyyel	10007432143
4. fekete bazalt	10007432144
5. antik acél	10007432145

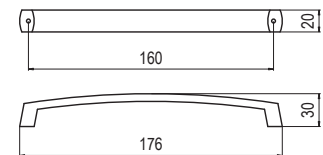

8059-240	cikkszám
matt króm	10007432150

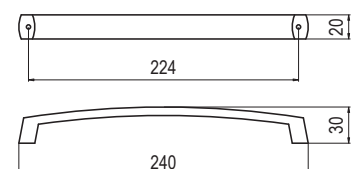

8014-184 - műanyag



szín	cikkszám
1. matt króm	10007432160
2. matt nikkell	10007432161
3. fekete, réz szegéllyel	10007432163
4. fekete, alumínium szegéllyel	10007432164
5. fekete bazalt	10007432165
6. antik acél	10007432166

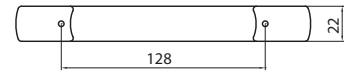

8045-36 - műanyag



szín	cikkszám
1. matt króm	10007432180
2. matt nikkell	10007432181
3. titánium	10007432182
4. fekete, réz szegéllyel	10007432183
5. fekete, alumínium szegéllyel	10007432184

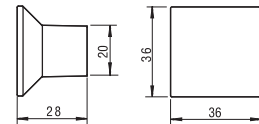

8013-148 - műanyag



szín	cikkszám
matt króm	10007432251

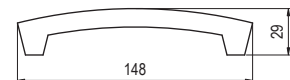
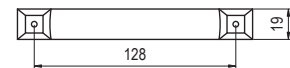

396/A - műanyag



szín	cikkszám
matt alumínium	10007808120

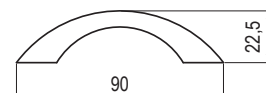
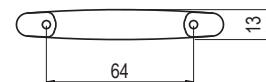

8193 - műanyag



hosszméret (mm)	furattáv (mm)	szín			
		1. fekete	2. fehér	3. króm	4. nikkel
200	160	10007433000	10007433001	10007433002	10007433003
246	192	10007433010	10007433011	10007433012	10007433013
320	128 x 2	10007433020	10007433021	10007433022	10007433023

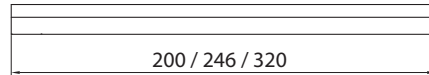

8214 - műanyag



szín	cikkszám
1. fehér	10007433101
2. króm	10007433102
3. nikkel	10007433103

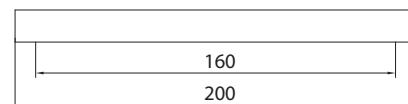
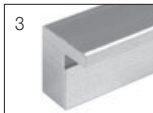

8217 - műanyag



hosszméret (mm)	furattáv (mm)	szín			
		1. fekete	2. fehér	3. króm	4. nikkel
200	160	10007433200	10007433201	10007433202	10007433203
246	192	10007433210	10007433211	10007433212	10007433213
320	128 x 2	10007433220	10007433221	10007433222	10007433223
420	192 x 2	10007433230	10007433231	10007433232	10007433233
510	160 x 3	10007433240	10007433241	10007433242	10007433243

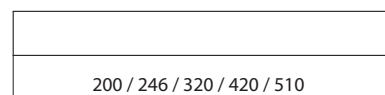
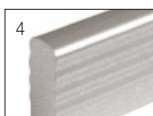
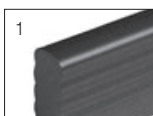

P 91/B-32 - műanyag



szín	cikkszám
rózsagyökér	10007801500

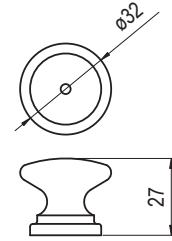

P 214/C-128 - műanyag



szín	cikkszám
matt króm - cseresznye	10007805609

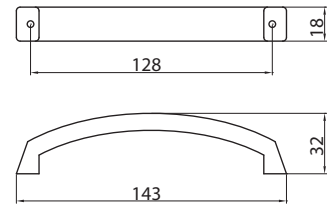

0549-134 - műanyag



szín	cikkszám
1. fekete	10007404200
2. króm	10007404220
3. matt króm	10007404240
4. matt nikkell	10007404260
5. arany	10007404280
6. piros	10007404282
7. sárga	10007404284
8. kék	10007404286
9. cseresznye	10007404290
10. fehér	10007404300

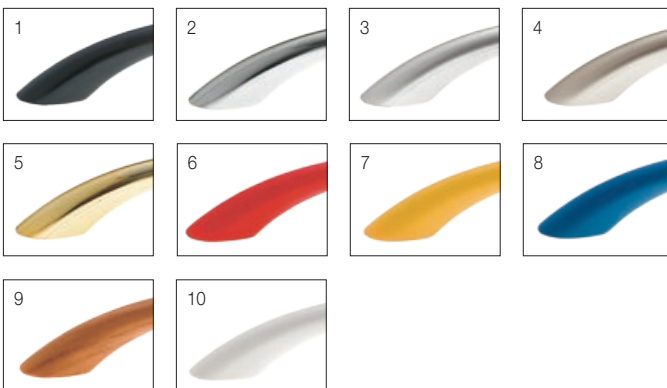
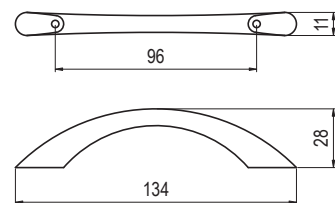

0549-97 - műanyag



szín	cikkszám
1. fekete	10007404900
2. króm	10007404920
3. matt króm	10007404940
4. matt nikkell	10007404960
5. arany	10007404970
6. fehér	10007405000

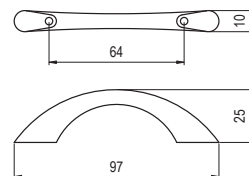
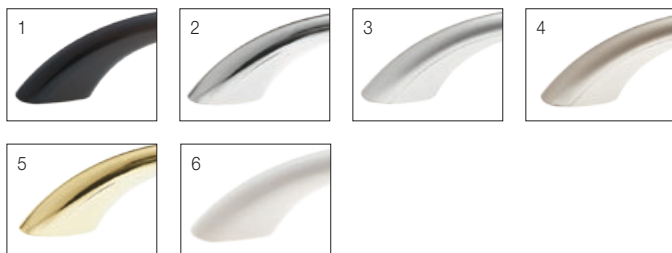

P 91/B-32 - műanyag



szín	cikkszám
1. arany	10007801000
2. fehér	10007801100
3. fekete	10007801200
4. króm	10007801300
5. matt króm	10007801303
6. matt nikkell	10007801306

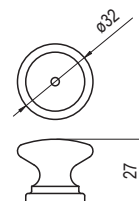

P 91-27 - műanyag



szín	cikkszám
1. arany	10007800100
2. fehér	10007800200
3. fekete	10007800300
4. króm	10007800500

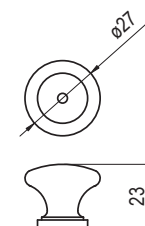
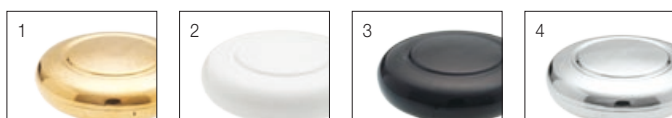

P 201/B-96 - műanyag



szín	cikkszám
rózsagyökér	10007804300

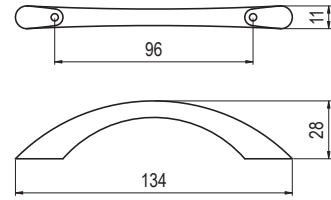

P 201/A-64 - műanyag



szín	cikkszám
króm	10007802400

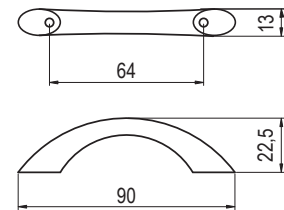

P 201/C-128 - műanyag



szín	cikkszám
1. fehér	10007804700
2. fekete	10007804800
3. króm	10007805000
4. matt króm	10007805003
5. matt nikkél	10007805006

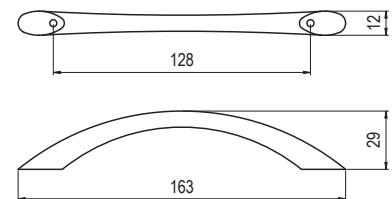
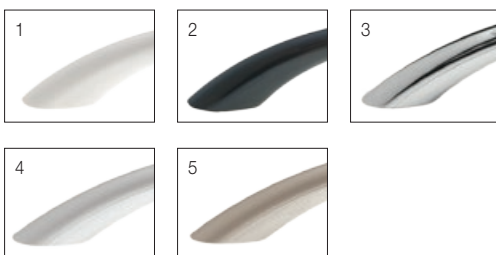

SM 391-34 - műanyag



szín	cikkszám
arany - fehér	10007423400

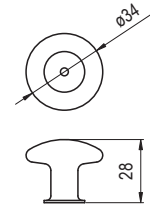

0287-106 - műanyag



szín	cikkszám
fehér	10007401200

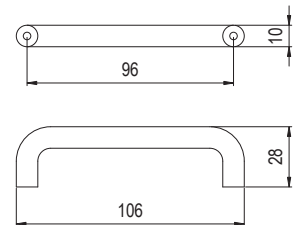

SM 447-32 / SM 447-40 - műanyag



SM 447-32	cikkszám
fehér	10007420800

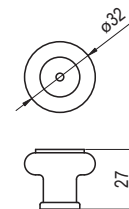

SM 447-40	cikkszám
fehér	10007421200

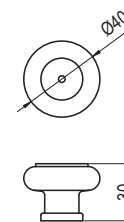

SM 592-124 - műanyag



szín	cikkszám
fehér - arany	10007426000

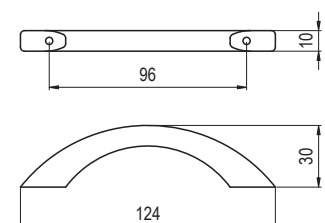

57 - műanyag



szín	cikkszám
matt alumínium	10007808070

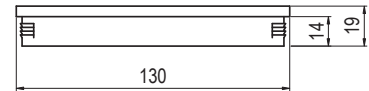
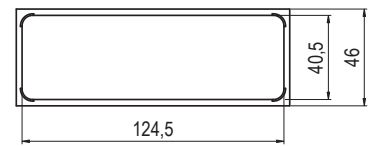

bemárási méret:
125 x 41 x 15 mm

P 273-35 - műanyag



szín	cikkszám
1. fehér	10007807202
2. fekete	10007807204
3. arany	10007807206
4. króm	10007807208
5. matt króm	10007807210

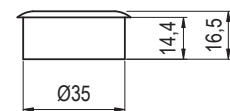
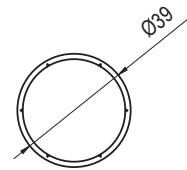

P 274-125 - műanyag



szín	cikkszám
1. fekete	10007807216
2. matt króm	10007807222
3. matt nikkelt	10007807224

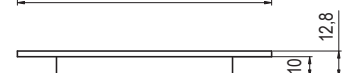
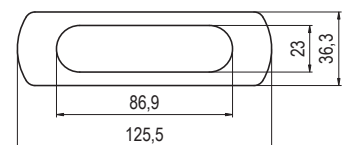

S 70-30 / S 70-35 / S 70-44 - fa

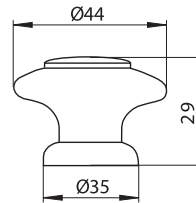
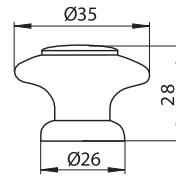
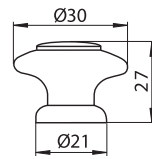
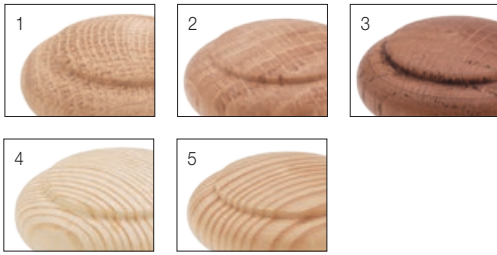

S 70-30	cikkszám
2. lakozott tölgy	10008003900
3. pácolt tölgy	10008004000
5. lakozott fenyő	10008004100

S 70-35	cikkszám
1. nyers tölgy	10008004200
2. lakozott tölgy	10008004300
3. pácolt tölgy	10008004400
4. nyers fenyő	10008004405
5. lakozott fenyő	10008004500

S 70-44	cikkszám
2. lakozott tölgy	10008004700
3. pácolt tölgy	10008004800
5. lakozott fenyő	10008004900

G 17-110 - fa



szín	cikkszám
nyers bükk	10008000305

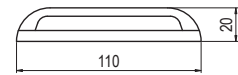
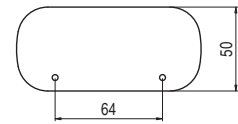

S 138-120 / S 138-88 - fa



S 138-120	cikkszám
1. pácolt tölgy	10008002200
2. lakozott fenyő	10008002300
3. nyers fenyő	10008002310

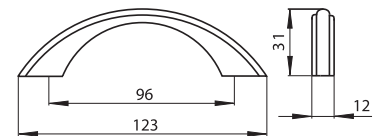

S 138-88	cikkszám
2. lakozott fenyő	10008002700

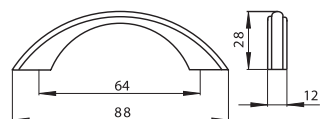

S 30-112 / S 30-82 - fa



S 30-112	cikkszám
1. nyers tölgy	10008002800
2. lakkozott tölgy	10008002900
3. lakkozott fenyő	10008003100

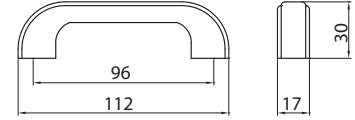

S 30-82	cikkszám
3. lakkozott fenyő	10008003500

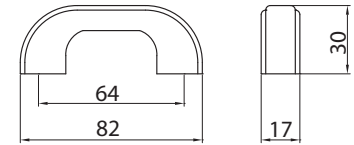

S 113-108 / S 113-76 - fa



S 113-108	cikkszám
lakkozott fenyő	10008000700

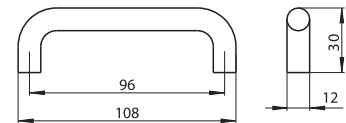

S 113-76	cikkszám
lakkozott fenyő	10008001100

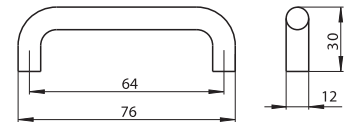

S 87-30 / S 87-35 / S 87-44 - fa



S 87-30	cikkszám
2. lakkozott tölgy	10008005100
4. lakkozott fenyő	10008005300

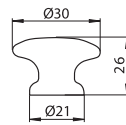

S 87-35	cikkszám
1. nyers tölgy	10008005400
2. lakkozott tölgy	10008005500
3. pácolt tölgy	10008005600
4. lakkozott fenyő	10008005700

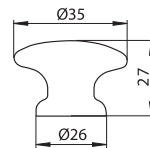

S 87-44	cikkszám
2. lakkozott tölgy	10008005900
3. pácolt tölgy	10008006000
4. lakkozott fenyő	10008006100

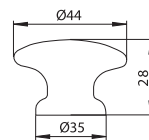

S 300-35 - fa

SIRO®
www.siro.cc

szín	cikkszám
nyers bükk	10008003600

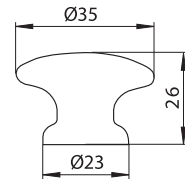

S 579-35 - fa



szín	cikkszám
1. lakkozott bükk	10008009070
2. olasz alma	10008009072
3. lakkozott juhar	10008009075

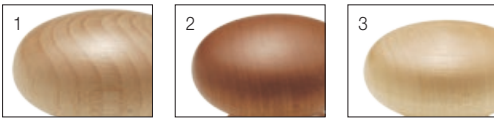
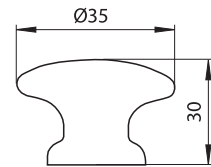

059-38 - fa



szín	cikkszám
lakkozott fenyő	10008009083

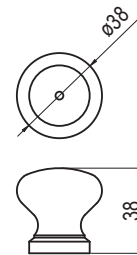

423-30 - fa



szín	cikkszám
1. lakkozott bükk	10008009100
2. olasz alma	10008009102
3. lakkozott juhar	10008009105

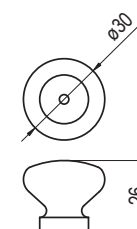

S 251-133 / S 251-170 - fa



szín	hosszméret (mm)	furattáv (mm)	cikkszám
lakkozott	133	96	10008008922
fenyő	170	128	10008008932

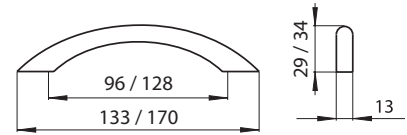

R-0961A - fa



szín	cikkszám
1. tölgy	10008009370
2. wenge	10008009371

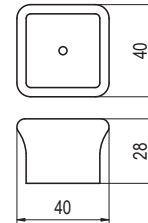
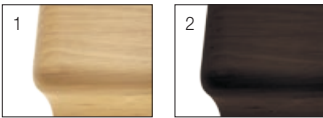

R1567 - fa



szín	cikkszám
wenge	10008009360

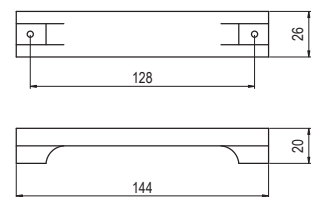

F 120-34 - fa

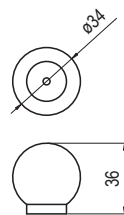

szín	cikkszám
fenyő	10007901000

F 125-34 - fa

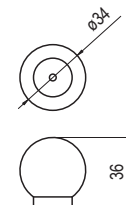

szín	cikkszám
tölgy natúr	10007901200

F 500-96 - fa



szín	cikkszám
fenyő	10007902300

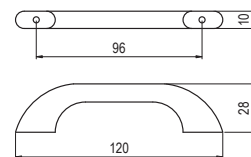

SIRO
www.siro.cc

F 510-128 - fa



szín	cikkszám
fenyő	10007902700

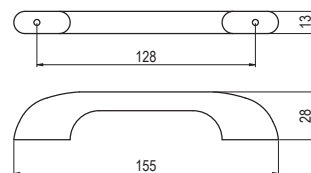

F 140-35 / F 144-35 / F 147-35 - fa



szín	cikkszám
1. F 140-35 fenyő	10007902000
2. F 144-35 bükk	10007902020
3. F 147-35 öregcseresznye	10007902050

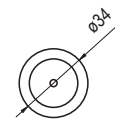

F 610-96 / F 619-96 - fa



szín	cikkszám
1. F 610-96 fenyő	10007905415
2. F 613-96 nyers bükk	10007905418
3. F 614-96 bükk	10007905419
4. F 615-96 tölgy natúr	10007905420
5. F 616-96 tölgy P43 pácolt	10007905421
6. F 617-96 öregcseresznye	10007905422
7. F 618-96 tölgy mahagóni	10007905423
8. F 619-96 fehér	10007905424

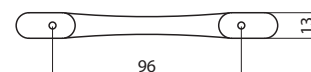

F 160-36 – F 167-36 - fa



szín	cikkszám
1. F 160-36 fenyő	10007902200
2. F 163-36 nyers bükk	10007902210
3. F 164-36 bükk	10007902220
4. F 165-36 tölgy natúr	10007902230
5. F 166-36 tölgy P43 pácolt	10007902240
6. F 167-36 öregcseresznye	10007902250

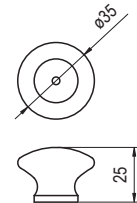

F 640-96 – F 647-96 - fa



szín	cikkszám
1. F 640-96 fenyő	10007905460
2. F 647-96 bükk-cseresznye	10007905467

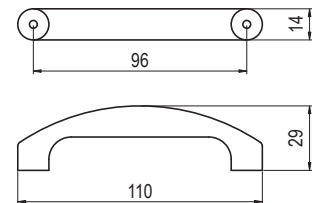
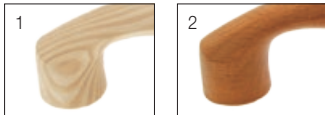

F 110-34 – F 119-34 - fa



szín	cikkszám
1. F 110-34 fenyő	10007900400
2. F 113-34 nyers bükk	10007900450
3. F 114-34 bükk	10007900500
4. F 115-34 tölgy natúr	10007900600
5. F 116-34 tölgy P43 pácolt	10007900700
6. F 117-34 öregcseresznye	10007900750
7. F 118-34 tölgy mahagóni	10007900800
8. F 119-34 fehér	10007900810

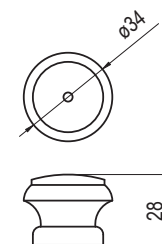
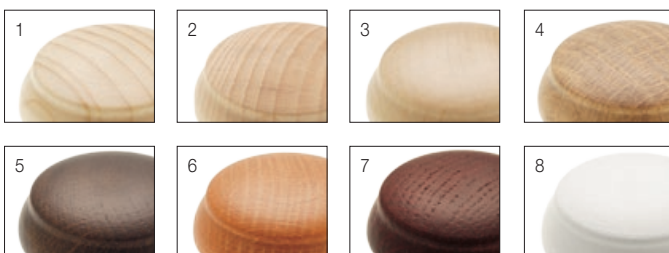

F 130-45 – F 139-45 - fa



szín	cikkszám
1. F 130-45 fenyő	10007901500
2. F 133-45 nyers bükk	10007901550
3. F 134-45 bükk	10007901600
4. F 135-45 tölgy natúr	10007901700
5. F 136-45 tölgy P43 pácolt	10007901800
6. F 137-45 öregcseresznye	10007901850
7. F 138-45 tölgy mahagóni	10007901900
8. F 139-45 fehér	10007901910

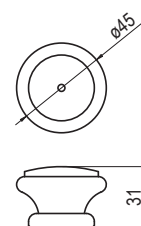

F 520-96 – F 526-96 - fa



szín	cikkszám
1. F 520-96 fenyő	10007903100
2. F 524-96 bükk	10007903150
3. F 525-96 tölgy natúr	10007903200
4. F 526-96 tölgy P43 pácolt	10007903300

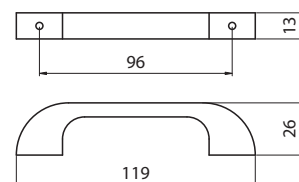
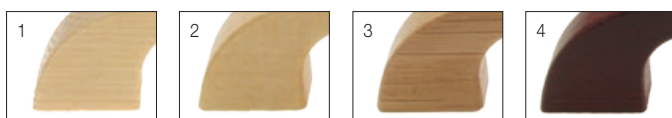

F 605-96 / F 607-96 - fa

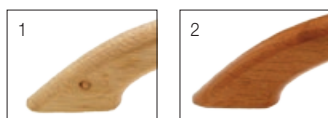

szín	cikkszám
1. F 605-96 tölgy natúr	10007905200
2. F 607-96 bükk-cseresznye	10007905350

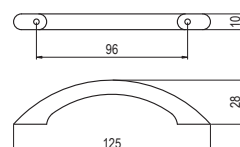

6017-128 - fa / fém



szín	cikkszám
bükk - matt króm	10008007200

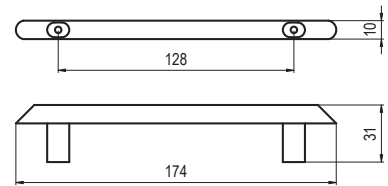

Fogantyúcsavarok

méret	cikkszám
M4 x 12	10007100000
M4 x 14	10007100010
M4 x 22	10007100020
M4 x 23	10007100030
M4 x 25	10007100040
M4 x 30	10007100050
M4 x 35	10007100060
M4 x 40	10007100065
M4 x 45	10007100070
M4 x 50	10007100080
M4 x 55	10007100090
M4 x 60	10007100100

H163-288 Furatsablon

műanyag

10007400000

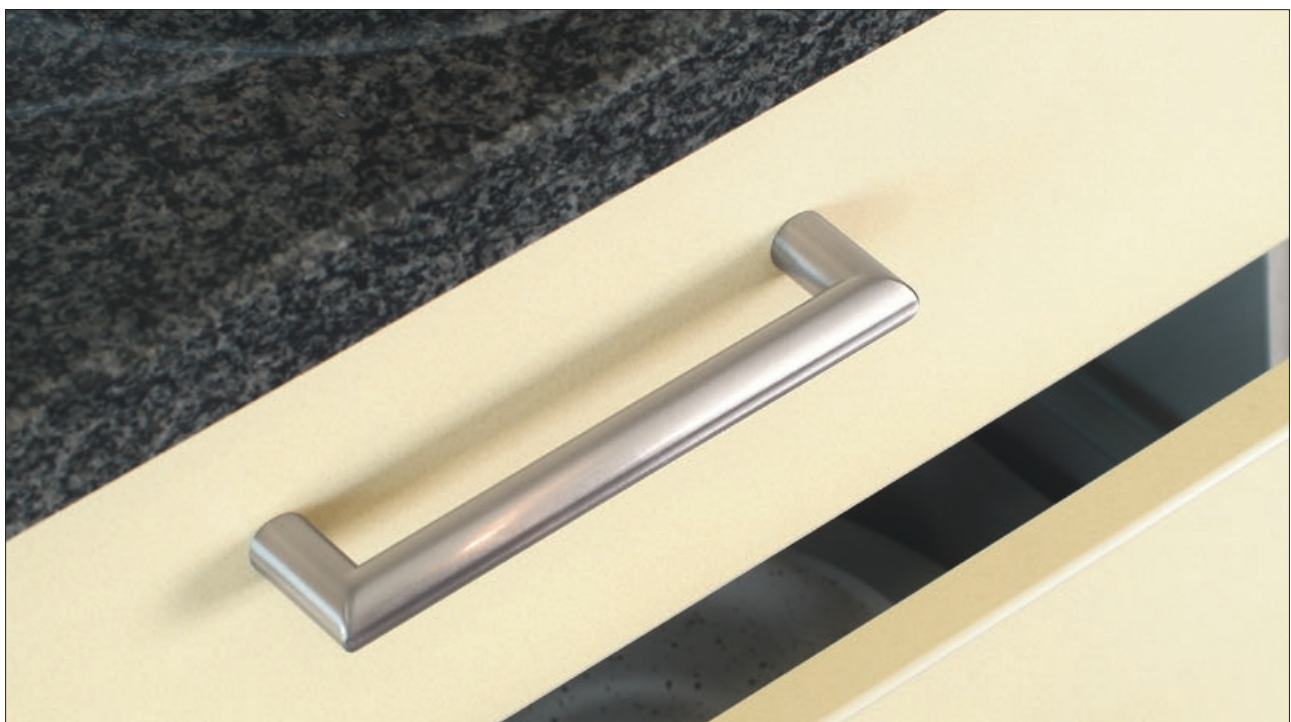
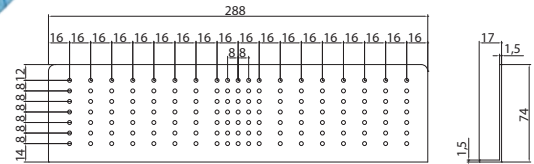
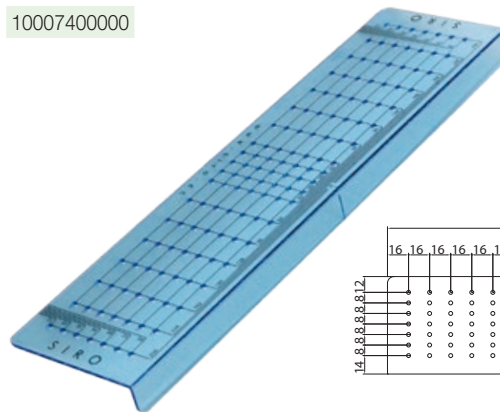

PA0027300 - fém Design: Marconato & Zappa

CONFAIÖNERI 

szín	cikkszám
1. Pretoria króm	10008870000
2. Botswana nikkell	10008870001
3. Patagónia ezüst	10008870002

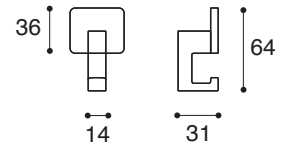

PA0027100 - fém Design: Bartoli Design



szín	cikkszám
1. Pretoria króm	10008870010
2. Botswana nikkell	10008870011
3. Patagónia ezüst	10008870012

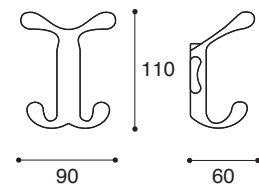

PA0027200 - fém Design: Marconato & Zappa



szín	cikkszám
1. Pretoria króm	10008870020
2. Botswana nikkell	10008870021
3. Patagónia ezüst	10008870022

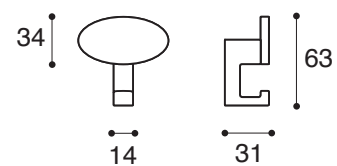

PA0027400 - fém Design: Bert & Bert

CONFAIÖNERI 

szín	cikkszám
1. Rogaland - fém	10008870031
2. Patagónia ezüst	10008870032

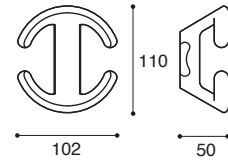
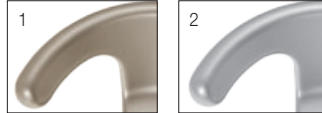

PA0028200 - fém Design: Bert & Bert



szín	cikkszám
1. Pretoria króm	10008870050
2. Botswana nikkell	10008870051
3. Patagónia ezüst	10008870052

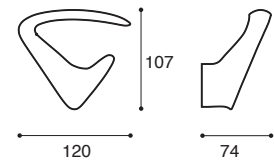

LID014800 - fém



szín	cikkszám
caledonia nikkell	10008870091

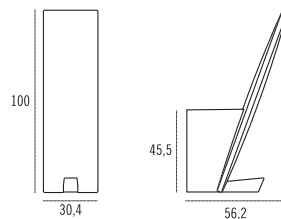

CONFALONIERI

2282-42 - inox - rozsdamentes acél



szín	cikkszám
rozsdamentes acél	10008821060

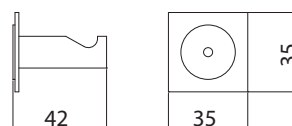

SIRO
www.siro.cc



Így is elhelyezhető

1658 - inox - rozsdamentes acél



szín	cikkszám
rozsdamentes acél	10008821000

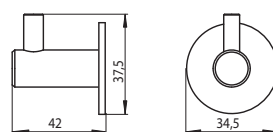

SIRO
www.siro.cc

2106 - inox - rozsdamentes acél



szín	cikkszám
rozsdamentes acél	10008821010

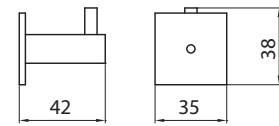

2315/N1 - inox - rozsdamentes acél



szín	cikkszám
rozsdamentes acél	10008821150

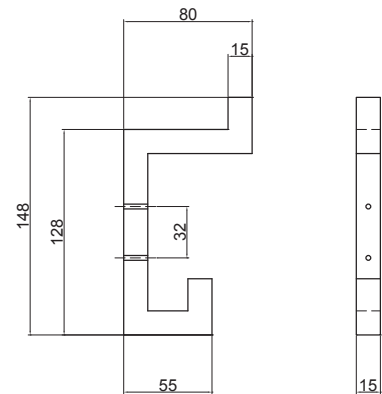

2316/N1 - inox - rozsdamentes acél



szín	cikkszám
rozsdamentes acél	10008821160

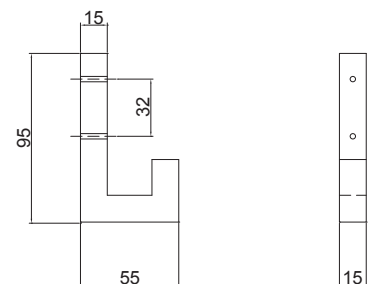

2322/N1kv1s - inox - rozsdamentes acél, öntapadós



szín	cikkszám
rozsdamentes acél	10008821100

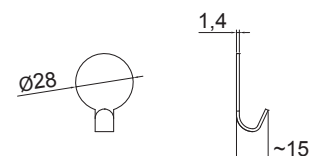

2301 - inox - rozsdamentes acél

S I R O[®]
www.siro.cc

szín	cikkszám
rozsdamentes acél	10008821070

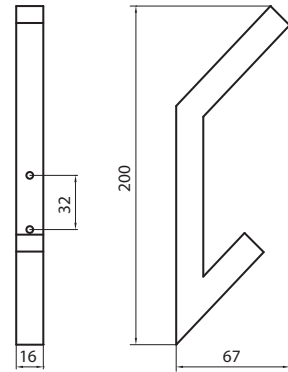

2302 - inox - rozsdamentes acél



szín	cikkszám
rozsdamentes acél	10008821080

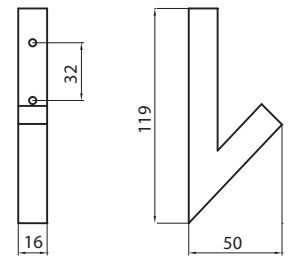

2319 - fém, öntapadós, 3 db/csomag



szín	cikkszám
nikkel	10008821090

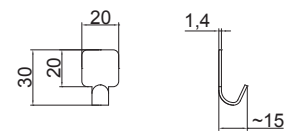

2334 - fém, öntapadós



szín	cikkszám
króm	10008821110

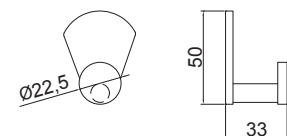

2335 - fém, öntapadós



szín	cikkszám
nikkel	10008821120

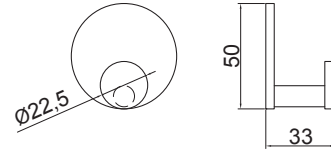

2324 - fém



szín	cikkszám
1. nikkel	10008821130
2. króm	10008821131
3. szálcsiszolt acél	10008821132
4. fehér	10008821133
5. fekete	10008821134

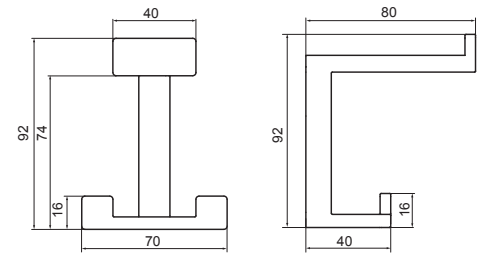

2326 - fém



szín	cikkszám
1. nikkel	10008821140
2. króm	10008821141
3. szálcsiszolt acél	10008821142
4. fehér	10008821143
5. fekete	10008821144

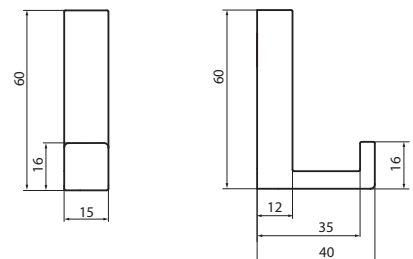

2325 - fém



szín	cikkszám
1. nikkel	10008821170
2. króm	10008821171
3. szálcsiszolt acél	10008821172
4. fehér	10008821173
5. fekete	10008821174

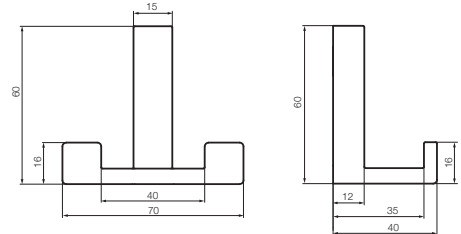

2313 - alumínium



szín	cikkszám
alumínium	10008821180

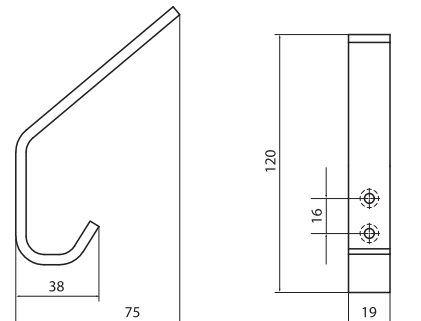

2314 - alumínium



szín	cikkszám
alumínium	10008821190

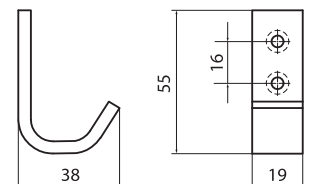

1871 - fém



szín	cikkszám
1. alumínium	10008821200
2. nikkell	10008821201

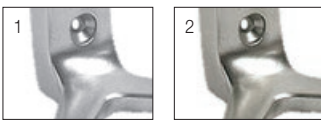
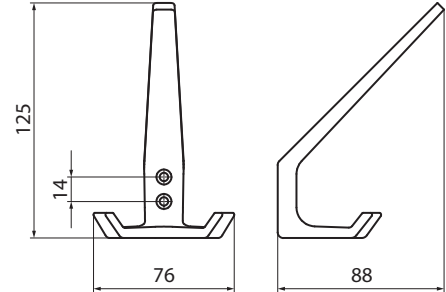

1785 - fém



szín	cikkszám
1. alumínium	10008821210
2. nikkell	10008821211

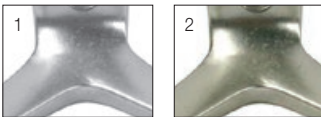
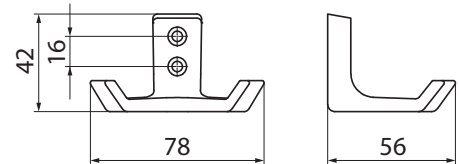

2330 - fém, öntapadós



szín	cikkszám
1. króm	10008821220
2. nikkell	10008821221

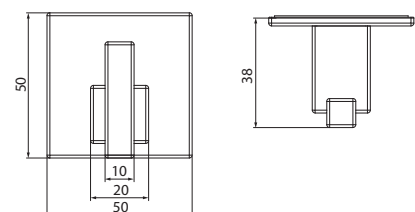

2331 - fém - öntapadós



szín	cikkszám
1. króm	10008821230
2. nikkell	10008821231

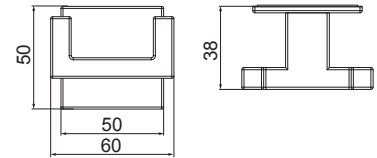

2332 - fém - öntapadós



szín	cikkszám
1. króm	10008821240
2. nikkell	10008821241

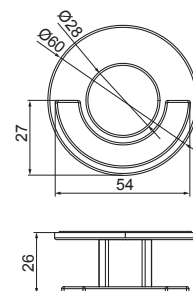

2235 - fém, 3 db/csomag



szín	cikkszám
acél	10008821270

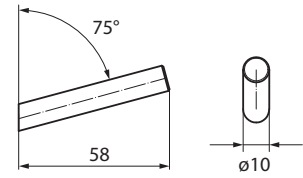

2236 - fém



szín	cikkszám
acél	10008821260

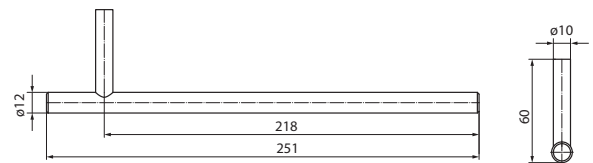

E1016 - fém



szín	cikkszám
1. króm	10008860160
2. nikkel	10008860161
3. matt króm	10008860162

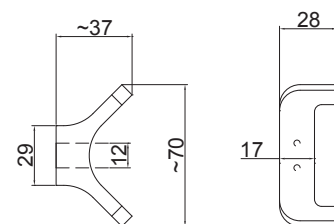

E1014 - fém



szín	cikkszám
nikkel	10008860140

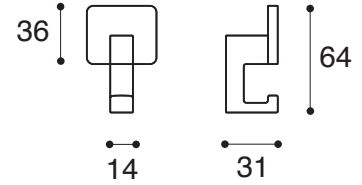

E1017 - fém



szín	cikkszám
1. króm	10008860170
2. nikkel	10008860171
3. matt króm	10008860172

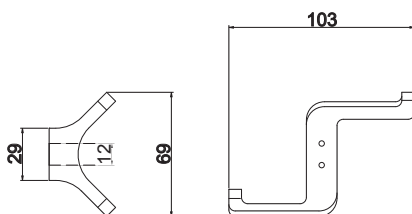

E1018 - fém



szín	cikkszám
1. króm	10008860180
2. matt króm	10008860181
3. matt nikkel	10008860182

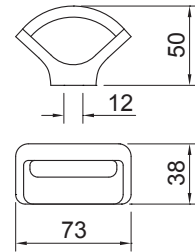

E1010 - fém



szín	cikkszám
króm - nikkel	10008860100

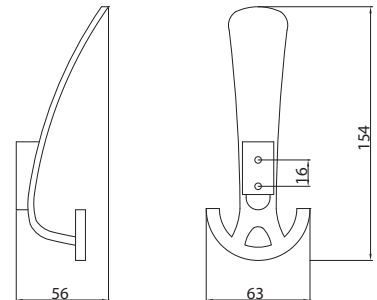

E1011 - fém



szín	cikkszám
króm - nikkel	10008860110

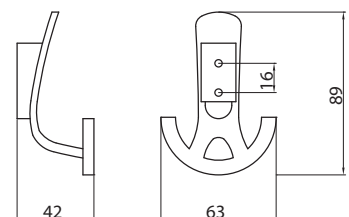

1278 - fém



szín	cikkszám
1. króm	10008820240
2. nikkel	10008820241
3. alumínium	10008820243

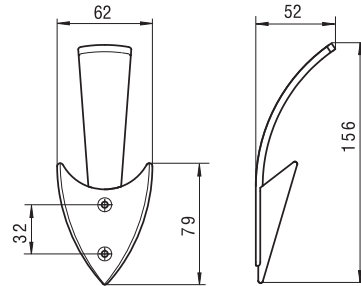

1279 - fém



szín	cikkszám
1. króm	10008820250
2. nikkel	10008820251
3. alumínium	10008820253

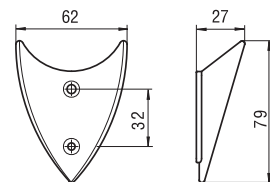

1282 - fém



szín	cikkszám
aluminium	10008820283

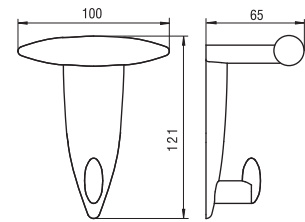

851 - fém



szín	cikkszám
1. króm	10008820040
2. nikkel	10008820041

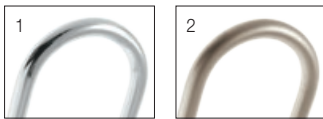
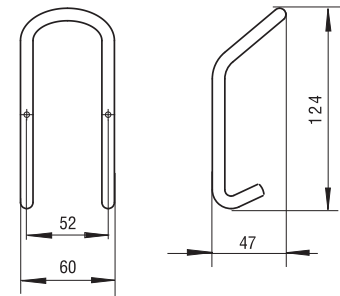

1672 - fém

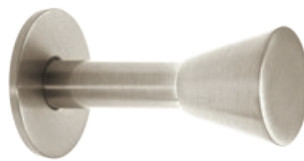

szín	cikkszám
nikkel	10008820420

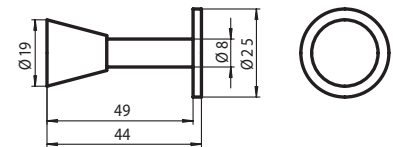

2107 - fém



szín	cikkszám
1. króm	10008820600
2. matt króm	10008820601

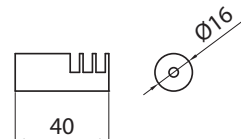
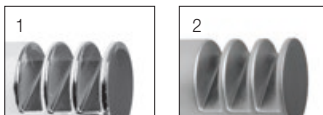

1280 / 1281 - fém



1280	cikkszám
1. króm	10008820260
2. nikkel	10008820261
3. réz	10008820262
4. alumínium	10008820263

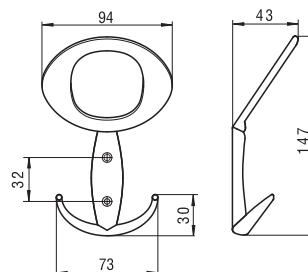

1281	cikkszám
1. króm	10008820270
2. nikkel	10008820271
3. réz	10008820272
4. alumínium	10008820273

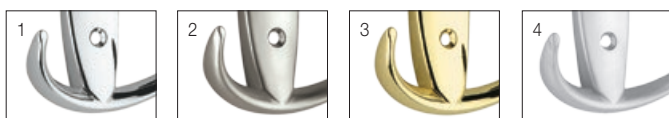
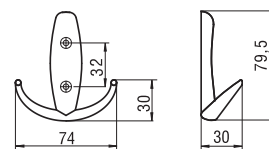

1653 / 1654 - fém



1653	cikkszám
alumínium	10008820400

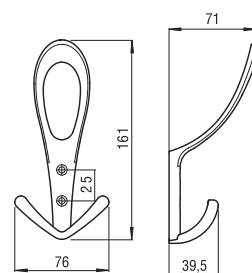

1654	cikkszám
alumínium	10008820410

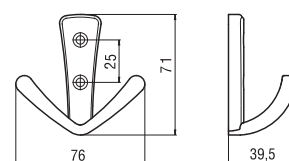

1096 / 1097 - fém



1096	cikkszám
1. króm	10008805000
2. antikolt	10008805100
3. matt króm	10008805200
4. nikkel	10008805300
5. kovácsoltvas	10008805500

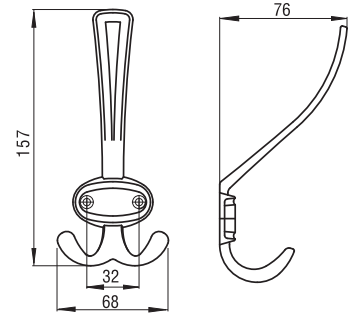

1097	cikkszám
1. króm	10008805600
2. antikolt	10008805700
3. matt króm	10008805800
4. nikkel	10008805900
5. kovácsoltvas	10008806100

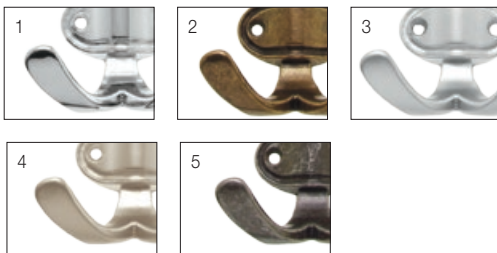
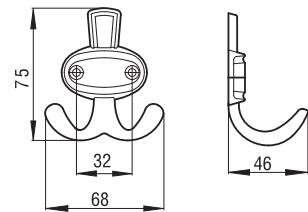

817 - fém



szín	cikkszám
antikolt	10008803700

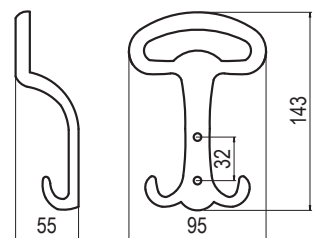

1236 - fém



szín	cikkszám
1. króm	10008820200
2. nikkel	10008820201

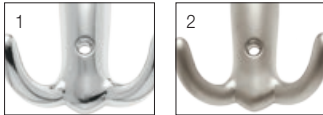
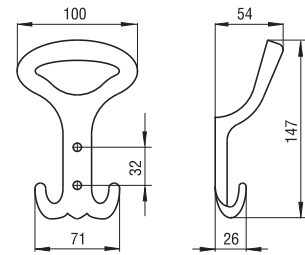

1237 - fém



szín	cikkszám
1. króm	10008820210
2. nikkel	10008820211
3. antikolt	10008820213

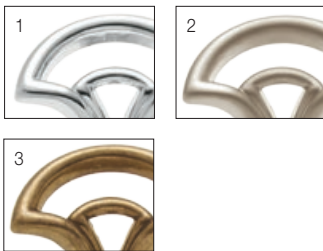
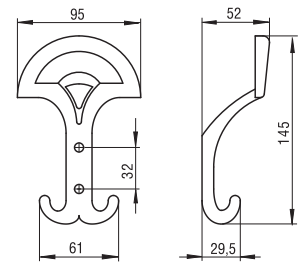

553 / 554 - fém



553	cikkszám
arany	10008802800

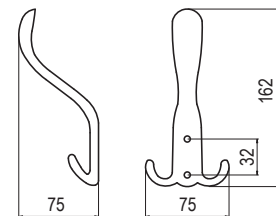

554	cikkszám
arany	10008803100

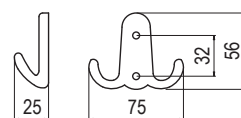

547 / 548 - fém



547	cikkszám
antikolt	10008802100

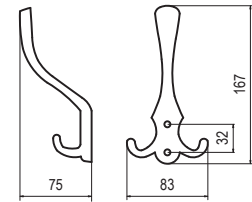

548	cikkszám
antikolt	10008802400

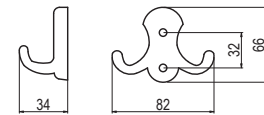

WAP801 / WAP802 - fém



WAP801	cikkszám
antik nikkel	10008871000

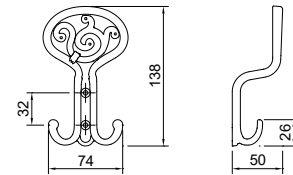

WAP802	cikkszám
antik nikkel	10008871010

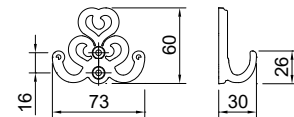

Stílusban illeszkedő
polctartók
ezen az oldalon
találhatók:

6.24



557 / 558 - fém



557	cikkszám
antikolt	10008803200

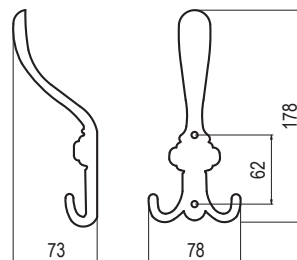

558	cikkszám
antikolt	10008803400

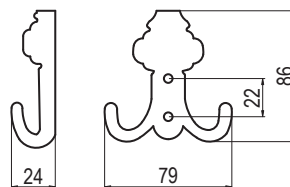

1420 / 1421 - fém



1420	cikkszám
1. antikolt	10008820311
2. matt fekete	10008820312

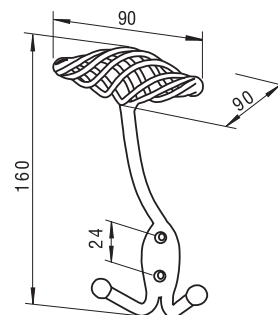

1421	cikkszám
1. antikolt	10008820321
2. matt fekete	10008820322

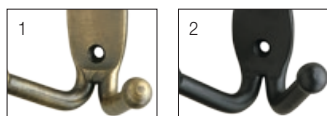
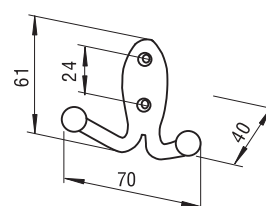

1230 - fém



szín	cikkszám
antikolt ezüst	10008820170

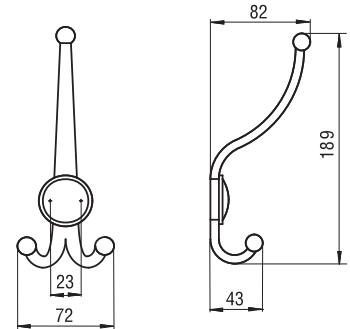

430 / 431 - fém



430	cikkszám
1. antikolt	10008801460
2. kovácsoltvas	10008801465

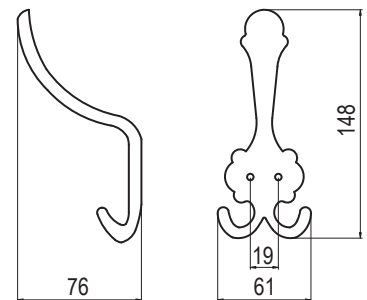

431	cikkszám
1. antikolt	10008801470
2. kovácsoltvas	10008801475

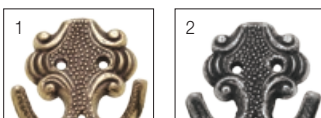
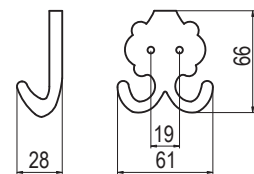

505 - fém



505	cikkszám
1. króm	10008801800
2. antikolt	10008801900
3. arany	10008802000

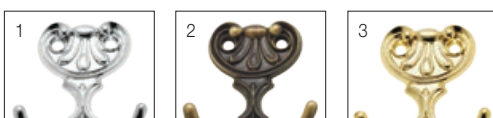
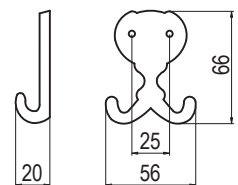

1981 / 1982 - fém / műanyag



1981	cikkszám
1. króm - fehér	10008820470
2. antikolt réz - beige	10008820480

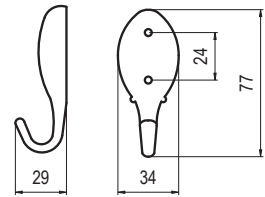

1982	cikkszám
1. króm - fehér	10008820490
2. antikolt réz - beige	10008820500

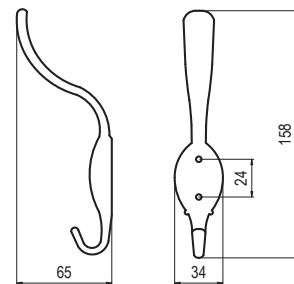

1821 - fém



szín	cikkszám
1. antik réz	10008820460
2. szálciszolt acél	10008820461

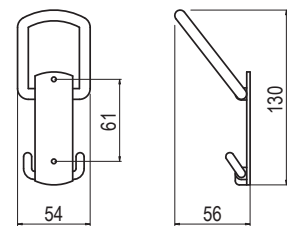

T 210 - fém



szín	cikkszám
1. fehér	10008850500
2. fekete	10008850600
3. króm	10008850700
4. réz	10008850800

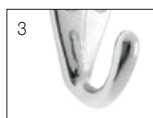
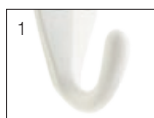
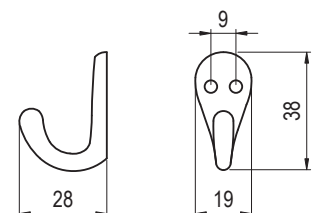

SIRO
www.siro.cc

SIRO
www.siro.cc

T 211 - fém



szín	cikkszám
1. fehér	10008850900
2. fekete	10008851000
3. króm	10008851100
4. réz	10008851200

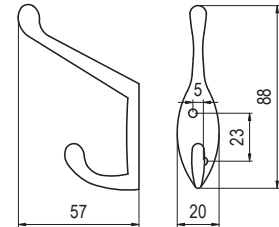

T 212 - fém

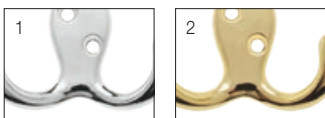

szín	cikkszám
1. króm	10008851300
2. réz	10008851400

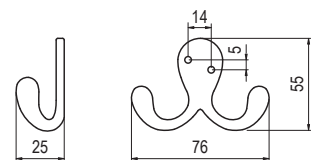

T 213 - fém



szín	cikkszám
1. fehér	10008851500
2. fekete	10008851600
3. króm	10008851700

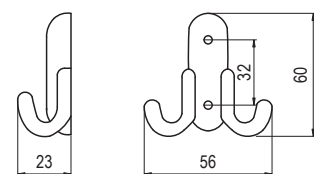

E1001 - fém



szín	cikkszám
1. króm	10008860010
2. nikkel	10008860011

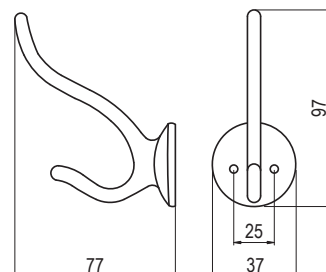

E1002 - fém



szín	cikkszám
1. króm	10008860020
2. nikkel	10008860021
3. matt króm	10008860022

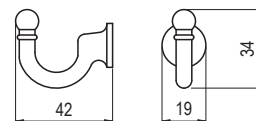

E1004 - fém

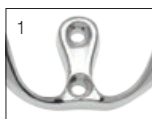

szín	cikkszám
1. króm	10008860040
2. nikkel	10008860041
3. matt króm	10008860042

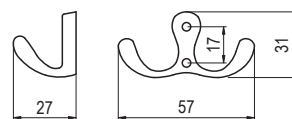

E1005 - fém



szín	cikkszám
1. króm	10008860050
2. nikkel	10008860051
3. matt króm	10008860052

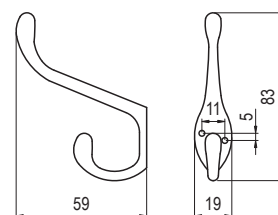

E1006 - fém

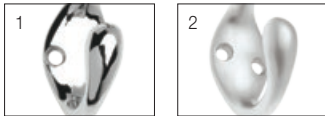

szín	cikkszám
1. króm	10008860060
2. matt króm	10008860062

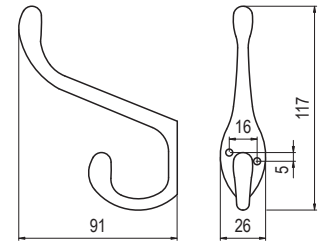

E1000 - fém



szín	cikkszám
1. króm	10008860000
2. nikkell	10008860001
3. matt króm	10008860002

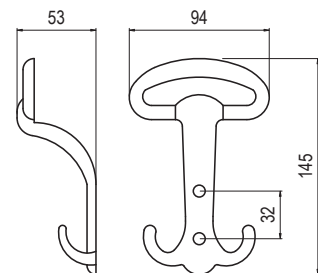

E1003 - fém



szín	cikkszám
1. króm	10008860030
2. nikkell	10008860031
3. matt króm	10008860032

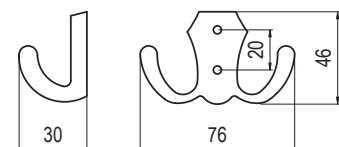

E1007 - fém



szín	cikkszám
1. króm	10008860070
2. nikkel	10008860071
3. matt króm	10008860072

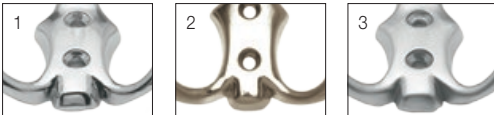
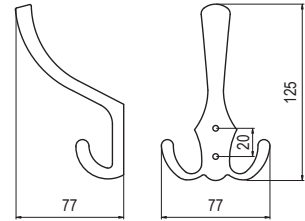

E1008 / E1009 - fém



E1008	cikkszám
1. nikkel	10008860081
2. matt króm	10008860082
3. fényes antikolt bronz	10008860083

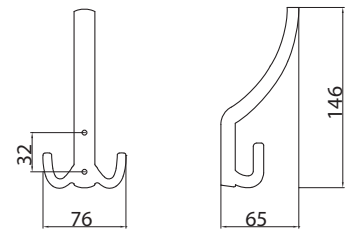

E1009	cikkszám
1. nikkel	10008860091
2. matt króm	10008860092
3. fényes antikolt bronz	10008860093

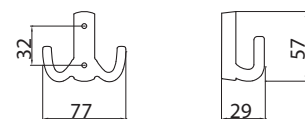

EM-072-A - fém



szín	cikkszám
1. króm	10008865000
2. matt króm	10008865001

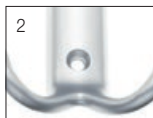
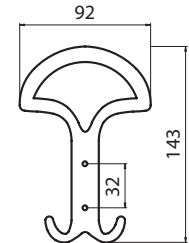

EM-073-A - fém



szín	cikkszám
1. króm	10008865010
2. matt króm	10008865011

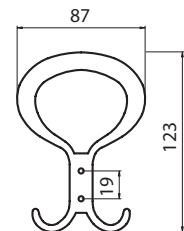

743 - fém, öntapadós



szín	cikkszám
króm	10008820700

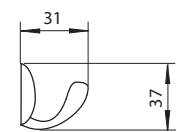

2295-121 - fém / műanyag, kihajtható



szín	cikkszám
króm - fehér	10008820690

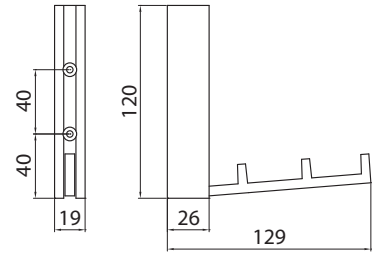

0487 / 0488 - műanyag



0487	cikkszám
fehér	10008800200

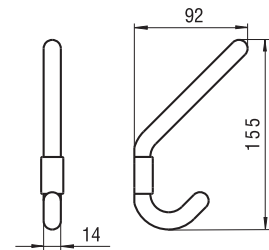

0488	cikkszám
fehér	10008800700

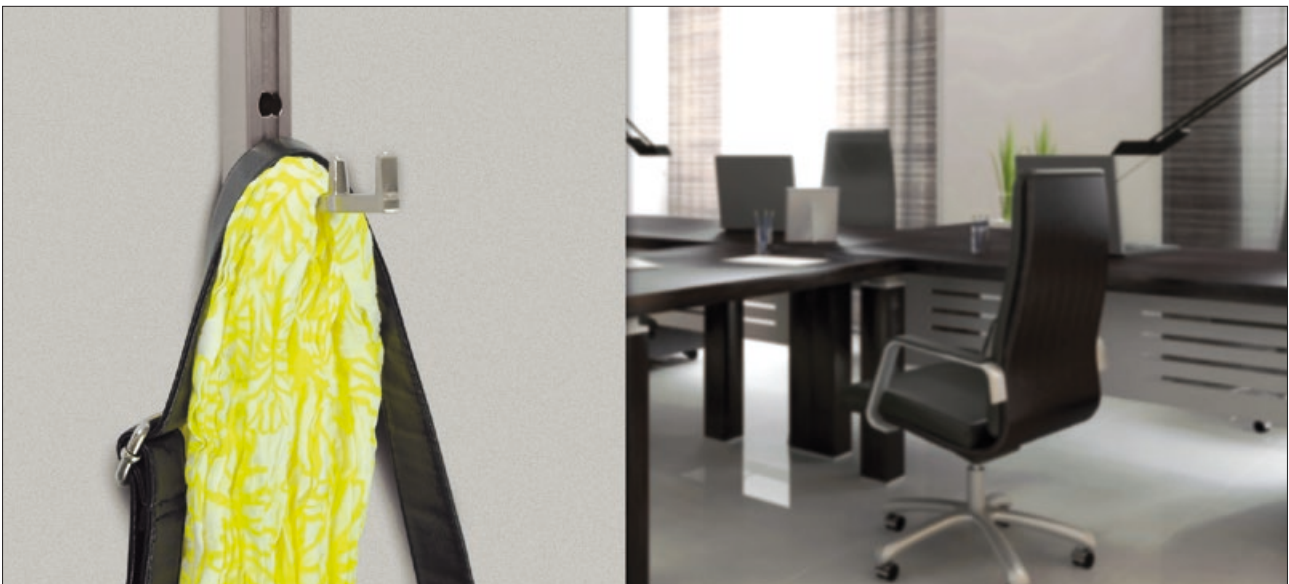
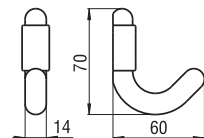

2050 - műanyag / fém



szín	cikkszám
sárga - alumínium	10008820510

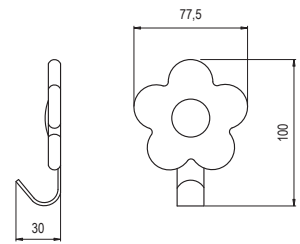

2051 - műanyag / fém



szín	cikkszám
kék - alumínium	10008820520

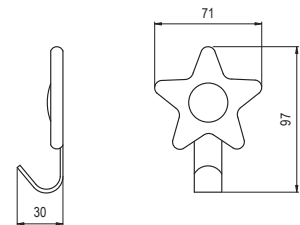

2052 - műanyag / fém



szín	cikkszám
piros - alumínium	10008820530

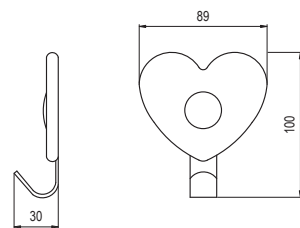

8165 - műanyag, öntapadós



szín	cikkszám
1. vonat	10008905400
2. autó	10008905401
3. tündér	10008905402

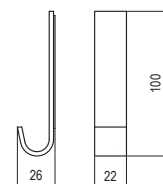

1292 - fém / fa



szín	cikkszám
bükk - szürke	10008904020

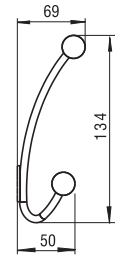
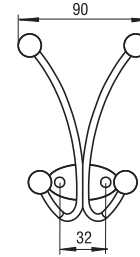

1293 / 1294 - fém / fa



1293	cikkszám
bükk - szürke	10008904030

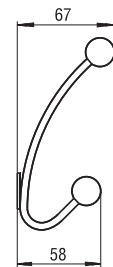
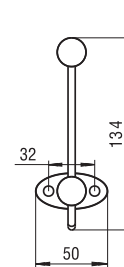

1294	cikkszám
bükk - szürke	10008904040

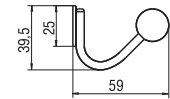
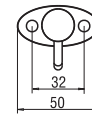

2196-300 / 2196-460 - inox - rozsdamentes acél

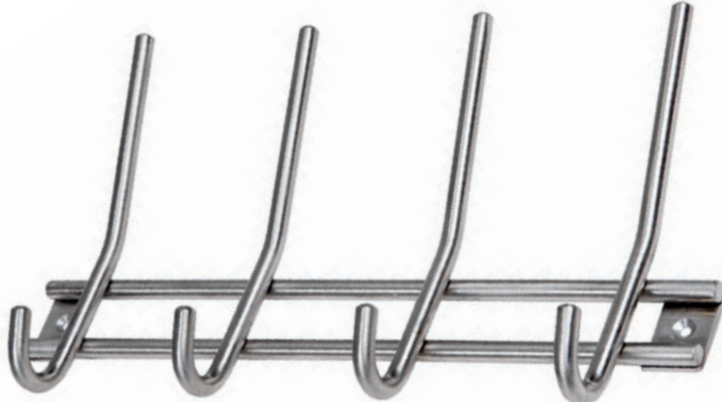

2196-300	cikkszám
rozsdamentes acél	10008821020

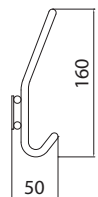
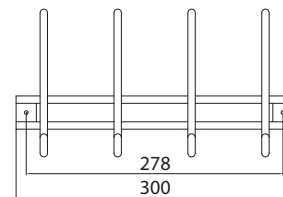

2196-460	cikkszám
rozsdamentes acél	10008821030

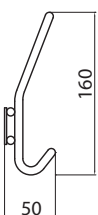
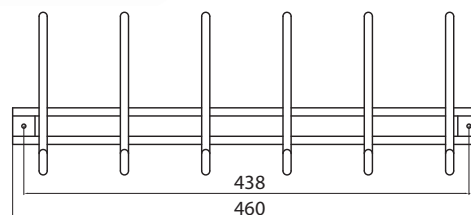

2256-300 - inox - rozsdamentes acél



szín	cikkszám
rozsdamentes acél	10008821040

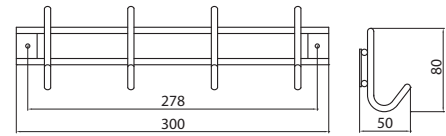
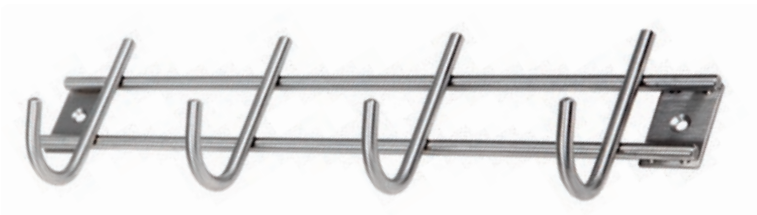

1977-255 / 1977-375 - fém, ajtóra akasztható



1977-255	cikkszám
matt nikkell	10008820641

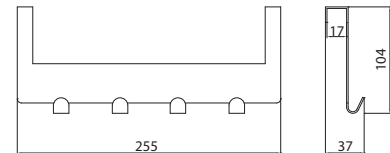

1977-375	cikkszám
matt nikkell	10008820651



2180-100 - fém, ajtóra akasztható, 3 db/csomag



szín	cikkszám
króm	10008820670

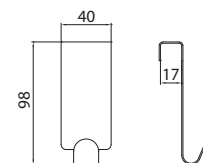

1603-240 - fém



szín	cikkszám
1. króm	10008905000
2. matt nikkell	10008905010

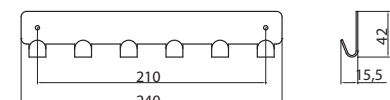



8161 - műanyag

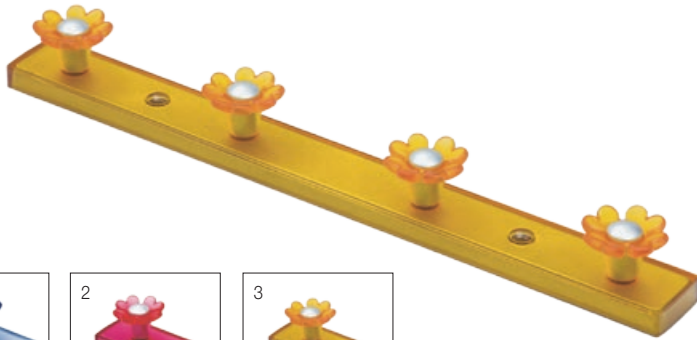

szín	cikkszám
1. kék - alumínium	10008905340
2. rózsaszín - alumínium	10008905341
3. narancs - alumínium	10008905342

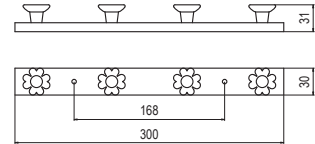

8162 - műanyag

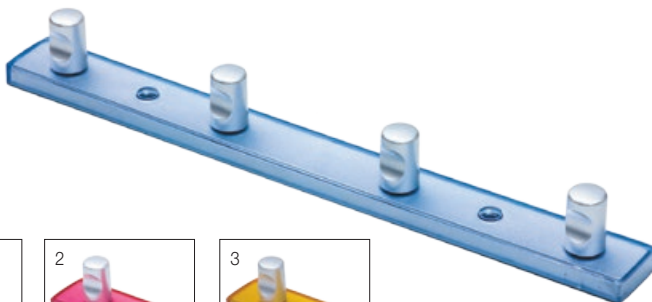

szín	cikkszám
1. világoskék - alu	10008905351
2. rózsaszín - alu	10008905352
3. narancs - alu	10008905353

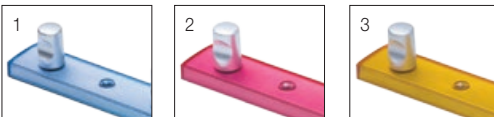
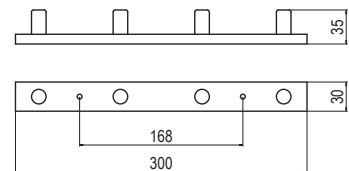

8167 - műanyag

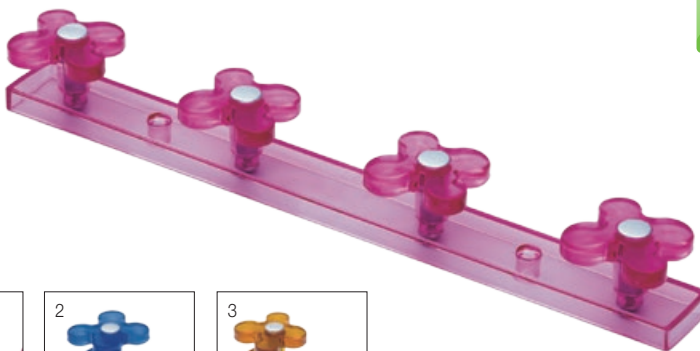

szín	cikkszám
1. rózsaszín - alumínium	10008905410
2. kék - alumínium	10008905411
3. narancs - alumínium	10008905412

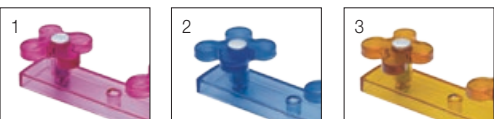
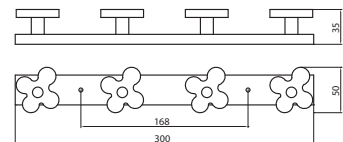

8168 - műanyag



szín	cikkszám
1. kék - alumínium	10008905420
2. rózsaszín - alumínium	10008905421
3. narancs - alumínium	10008905422

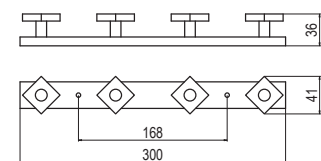

8163 - műanyag



szín	cikkszám
matt króm - áttetsző	10008905360

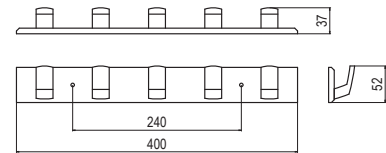

8170 - műanyag



szín	cikkszám
fekete bőrh. - króm	10008905430

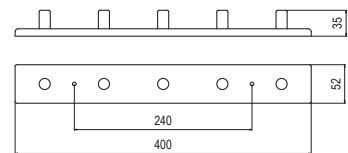

8171 - műanyag

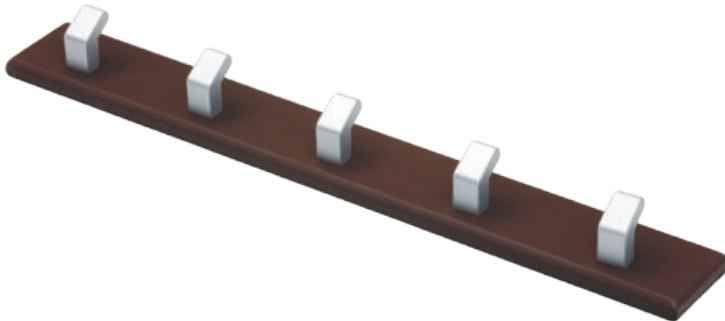

szín	cikkszám
barna bőrh. - alu.	10008905440

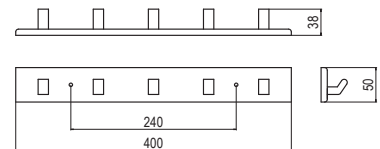

8164 - műanyag

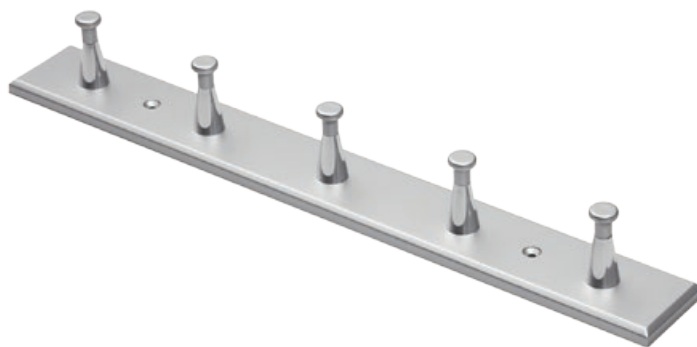

szín	cikkszám
1. fehér - króm	10008905370
2. matt króm - króm	10008905371
3. wenge - króm	10008905372
4. vonat	10008905380
5. autó	10008905381
6. tündér	10008905382

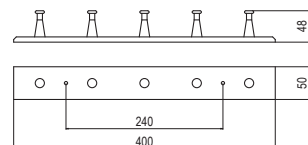

1674-550 - fém



szín	cikkszám
alumínium	10008820630

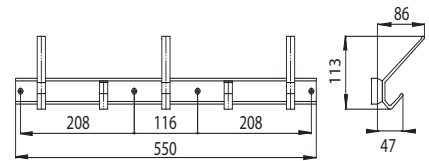
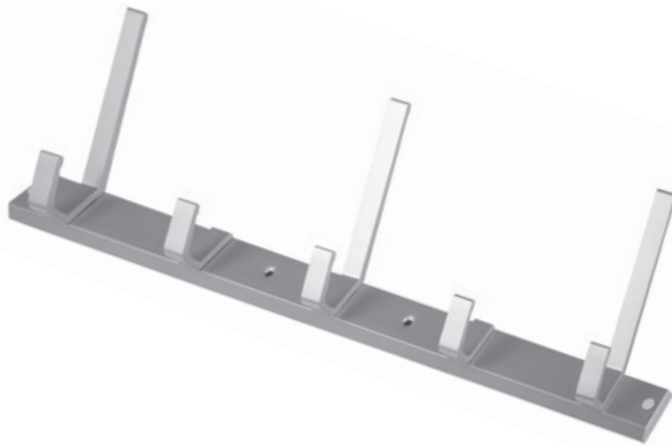

8177 - műanyag

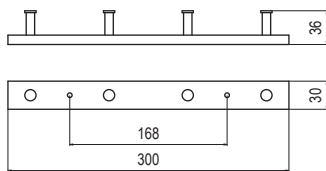
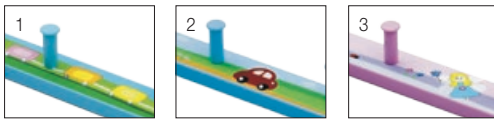

szín	cikkszám
1. vonat	10008905390
2. autó	10008905391
3. tündér	10008905392



S666-440 - fa / fém

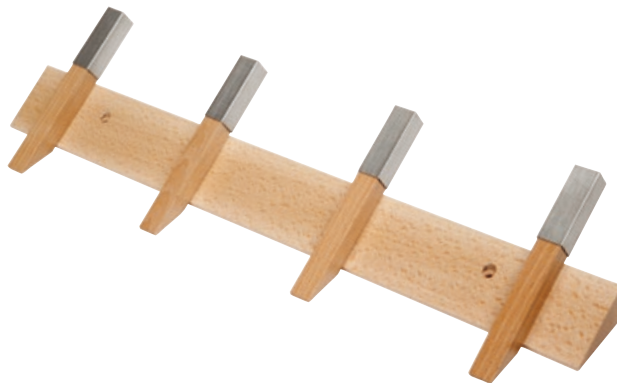

szín	cikkszám
1. natúr	10008904231
2. wenge	10008904232

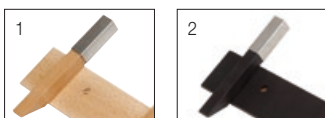
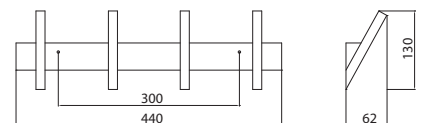

S 592-420 - fa



szín	cikkszám
1. fenyő	10008905320
2. alumínium	10008905321

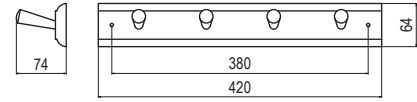
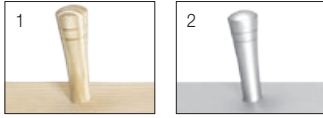

300 / 380 - fa



300	cikkszám
1. olasz alma	10008903419

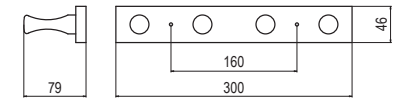

380	cikkszám
1. olasz alma	10008903427
2. bükk	10008903435
3. fehér	10008903459

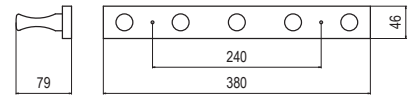

362 - fa



szín	cikkszám
fenyő	10008903470

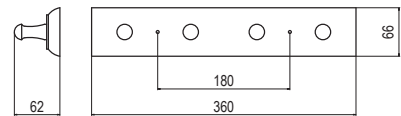

450 - fa



szín	cikkszám
fenyő	10008903475

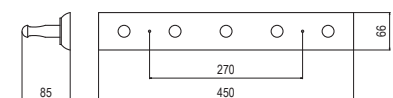

300 - fa / fém



szín	cikkszám
1. fehér	10008903589
2. fehér - réz	10008903591

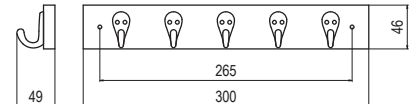

380 - fa / fém



szín	cikkszám
fehér	10008903505

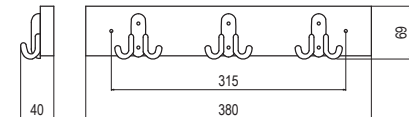

450 - fa / fém



szín	cikkszám
1. fehér	10008903530
2. fekete	10008903585

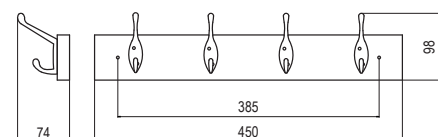

Cikkszám táblázat

Cikkszám	Típus	Oldal	Cikkszám	Típus	Oldal	Cikkszám	Típus	Oldal
10000691000	GOLA FELSŐ PROFIL 4200x57x26mm ALUMÍNÍUM	8.4	10000692300	GOLA 81\G38.A90AN VRN SAROKELEM KÜLSŐ 90° ALUMÍNÍUM	8.10	10007250420	H158-51 RU14 CICA GOMB SZÜRKE	8.155
10000691010	GOLA KÜLSŐ VÉGZÁRÓ FELSŐ SZETT JOBBOS-BALOS ALUMÍNÍUM	8.4	10000692305	GOLA 81\G39.A90AN VRN SAROKELEM KÜLSŐ 90° DUPLA ALUMÍNÍUM	8.10	10007250430	H159-50 RU15 BÉKA GOMB ZÖLD	8.155
10000691020	GOLA KÜLSŐ VÉGZÁRÓ FELSŐ SZETT JOBBOS-BALOS ALUMÍNÍUM	8.4	10000692310	GOLA 81\G38.A90BN VRN SAROKELEM BELSŐ 90° ALUMÍNÍUM	8.10	10007250440	1882-56 ZN50 REPÜLŐ GOMB ANTIKOLT EZÜST	8.152
10000691030	GOLA BELSŐ VÉGZÁRÓ FELSŐ SZETT JOBBOS-BALOS ALUMÍNÍUM	8.4	10000692315	GOLA 81\G39.A90BN VRN SAROKELEM BELSŐ 90° DUPLA ALUMÍNÍUM	8.10	10007250450	1883-109 ZN50 KISVONAT 76 ANTIKOLT EZÜST	8.153
10000691040	GOLA BELSŐ SAROK 29x29mm ALUMÍNÍUM	8.4	10000692320	GOLA 81\G38.A90AN VRN SAROKELEM KÜLSŐ 90° FEKETE	8.10	10007250460	1884-48 ZN50 VITORLÁS GOMB ANTIKOLT EZÜST	8.152
10000691050	GOLA KÜLSŐ SAROK 28x28mm ALUMÍNÍUM	8.5	10000692325	GOLA 81\G39.A90AN VRN SAROKELEM KÜLSŐ 90° DUPLA FEKETE	8.10	10007250470	1885-56 ZN50 KUTYA GOMB ANTIKOLT EZÜST	8.152
10000691100	GOLA KÖZBENSŐ PROFIL 4200x72x25mm ALUMÍNÍUM	8.5	10000692330	GOLA 81\G38.A90BN VRN SAROKELEM BELSŐ 90° FEKETE	8.10	10007250480	1886-36 ZN50 MACSKA GOMB ANTIKOLT EZÜST	8.152
10000691110	GOLA KÜLSŐ VÉGZÁRÓ, KÖZBENSŐ SZETT JOBBOS-BALOS ALUMÍNÍUM	8.5	10000692335	GOLA 81\G39.A90BN VRN SAROKELEM BELSŐ 90° DUPLA FEKETE	8.10	10007250491	1887-41 ZN50 PÓLÓ GOMB ANTIKOLT EZÜST	8.153
10000691120	GOLA KÜLSŐ VÉGZÁRÓ, KÖZBENSŐ SZETT JOBBOS-BALOS ALUMÍNÍUM	8.5	10000692340	GOLA 81\G38.A90AN VRN SAROKELEM KÜLSŐ 90° FEHÉR	8.10	10007250501	1888-40 ZN50 NADRÁG GOMB ANTIKOLT EZÜST	8.153
10000691130	GOLA BELSŐ VÉGZÁRÓ, KÖZBENSŐ SZETT JOBBOS-BALOS ALUMÍNÍUM	8.5	10000692345	GOLA 81\G39.A90AN VRN SAROKELEM KÜLSŐ 90° DUPLA FEHÉR	8.10	10007250510	01022-153 VILÁGÍTÓ TORONY 128 SOKSZÍNŰ	8.159
10000691140	GOLA KÜLSŐ SAROK 27,1x27,1mm ALUMÍNÍUM	8.5	10000692350	GOLA 81\G38.A90BN VRN SAROKELEM BELSŐ 90° FEHÉR	8.10	10007250520	01023-34 KORMÁNYKERÉK GOMB SOKSZÍNŰ	8.159
10000691200	GOLA FELSŐSZEKRENY VÍZSZINTES PROFIL 4200mm ALUMÍNÍUM	8.6	10000692355	GOLA 81\G39.A90BN VRN SAROKELEM BELSŐ 90° DUPLA FEHÉR	8.10	10007255010	MT 1317-26 GOMB KRÓM	8.67
10000691300	GOLA FÜGGŐLEGES DUPLA PROFIL 4700 mm ALUMÍNÍUM	8.6	10007100000	CSAVAR M4x12 KRÓM	8.191	10007255013	MT 1317-26 GOMB MATT KRÓM	8.67
10000691310	GOLA FÜGGŐLEGES SZIMPLA PROFIL 4700mm ALUMÍNÍUM	8.6	10007100010	CSAVAR M4x14 KRÓM	8.191	10007255015	MT 1317-26 GOMB MATT NIKKEL	8.67
10000691990	GOLA RÖGZÍTŐLEMEZ+CSAVAR .ACÉL	8.6	10007100020	CSAVAR M4x22 KRÓM	8.191	10007255019	MT 1318-121 96 MATT KRÓM	8.67
10000692000	GOLA 80\G38.AL07 PROFIL ALUMÍNÍUM	8.7	10007100030	CSAVAR M4x23 KRÓM	8.191	10007255021	MT 1318-121 96 MATT NIKKEL	8.67
10000692010	GOLA 80\G38.AL09 PROFIL FEKETE	8.7	10007100040	CSAVAR M4x25 KRÓM	8.191	10007255023	MT 1319-94 64 KRÓM	8.67
10000692020	GOLA 80\G38.AL52 PROFIL FEHÉR	8.7	10007100050	CSAVAR M4x30 KRÓM	8.191	10007255027	MT 1319-94 64 MATT NIKKEL	8.67
10000692050	GOLA 80\G39.AL07 PROFIL DUPLA ALUMÍNÍUM	8.7	10007100060	CSAVAR M4x35 KRÓM	8.191	10007255029	MT 1301-82 64 KRÓM	8.67
10000692060	GOLA 80\G39.AL09 PROFIL DUPLA FEKETE	8.7	10007100070	CSAVAR M4x40 KRÓM	8.191	10007255031	MT 1301-82 64 MATT KRÓM	8.67
10000692070	GOLA 80\G39.AL52 PROFIL DUPLA FEHÉR	8.7	10007100080	CSAVAR M4x45 KRÓM	8.191	10007255033	MT 1301-82 64 MATT NIKKEL	8.67
10000692100	GOLA 81\G38.A13 RÖGZÍTŐ ELEM 10db/csomag KÉK	8.8	10007100090	CSAVAR M4x50 KRÓM	8.191	10007300028	1021-146 96 ANTIKOLT BRONZ	8.97
10000692200	GOLA 81\G38.A12 VRN KÜLSŐ VÉGZÁRÓ ALUMÍNÍUM	8.9	10007100100	CSAVAR M4x55 KRÓM	8.191	10007300036	1021-146 96 MATT NIKKEL	8.97
10000692205	GOLA 81\G39.A12 VRN KÜLSŐ VÉGZÁRÓ DUPLA ALUMÍNÍUM	8.9	10007250010	H 022-56 TEKNŐSBÉKA GOMB SOKSZÍNŰ	8.158	10007300052	1029-147 128 MATT KRÓM	8.68
10000692210	GOLA 81\G38.A12 VRN KÜLSŐ VÉGZÁRÓ FEKETE	8.9	10007250013	H 023-55 TENGERI CSILLAG GOMB SOKSZÍNŰ	8.158	10007300056	1029-147 128 MATT NIKKEL	8.68
10000692215	GOLA 81\G39.A12 VRN KÜLSŐ VÉGZÁRÓ DUPLA FEKETE	8.9	10007250050	H 039-44 LEPKE GOMB PIROS	8.157	10007300100	1095-90 32 KRÓM	8.84
10000692220	GOLA 81\G38.A12 VRN KÜLSŐ VÉGZÁRÓ FEHÉR	8.9	10007250060	H 040-40 LEPKE GOMB KÉK	8.157	10007300200	1095-90 32 MATT KRÓM	8.84
10000692225	GOLA 81\G39.A12 VRN KÜLSŐ VÉGZÁRÓ DUPLA FEHÉR	8.9	10007250070	H 041-42 LEPKE GOMB NARANCS	8.157	10007303651	397-23 ÁTM: 23 mm ANTIKOLT BRONZ	8.104
10000692250	GOLA 81\G38.A13 VRN BELSŐ VÉGZÁRÓ ALUMÍNÍUM	8.9	10007250090	H 049-41 LEPKE GOMB SÁRGA	8.157	10007303661	397-35 ÁTM: 34,5 mm ANTIKOLT BRONZ	8.104
10000692255	GOLA 81\G39.A13 VRN BELSŐ VÉGZÁRÓ DUPLA ALUMÍNÍUM	8.9	10007250320	H147-47 RU1 AUTÓ GOMB PIROS	8.154	10007303681	398-70 ÁTM: 23 mm ANTIKOLT BRONZ	8.104
10000692260	GOLA 81\G38.A13 VRN BELSŐ VÉGZÁRÓ FEKETE	8.9	10007250330	H148-40 RU2 FOCILABDA GOMB FEKETE-FEHÉR	8.154	10007303691	398-98 ÁTM: 35 mm ANTIKOLT BRONZ	8.104
10000692265	GOLA 81\G39.A13 VRN BELSŐ VÉGZÁRÓ DUPLA FEKETE	8.9	10007250340	H149-44 RU3 SÁRGA VIRÁG GOMB SÁRGA	8.156	10007303800	885-208 128 MATT NIKKEL	8.17
10000692270	GOLA 81\G38.A13 VRN BELSŐ VÉGZÁRÓ FEHÉR	8.9	10007250341	H149-44 RU4 KÉK VIRÁG GOMB KÉK	8.156	10007303810	885-240 160 MATT NIKKEL	8.17
10000692275	GOLA 81\G39.A13 VRN BELSŐ VÉGZÁRÓ DUPLA FEHÉR	8.9	10007250342	H149-44 RU5 RÓZSASZÍN VIRÁG GOMB RÓZSASZÍN	8.156	10007303820	885-320 240 MATT NIKKEL	8.17
			10007250350	H150-53 RU6 BOHÓCHAL GOMB NARANCS	8.154	10007303830	885-368 288 MATT NIKKEL	8.17
			10007250360	H152-44 RU8 CSIGA GOMB SOKSZÍNŰ	8.155	10007303840	885-416 336 MATT NIKKEL	8.17
			10007250410	H157-50 RU13 SZINES CSILLAG GOMB SOKSZÍNŰ	8.154	10007303850	885-512 432 MATT NIKKEL	8.17
						10007303860	885-559 480 MATT NIKKEL	8.17
						10007303870	885-635 552 MATT NIKKEL	8.17
						10007303880	885-688 608 MATT NIKKEL	8.17
						10007303890	885-816 736 MATT NIKKEL	8.17
						10007303900	885-863 784 MATT NIKKEL	8.17
						10007303950	1209-30 ÁTM: 30 mm ANTIKOLT EZÜST	8.96
						10007303960	1209-40 ÁTM: 40 mm ANTIKOLT EZÜST	8.96
						10007304140	1253-180 128 KRÓM	8.66
						10007304141	1253-180 128 MATT NIKKEL	8.66

Cikkszám	Típus	Oldal
10007550081	132-64 64 KRÓM	8.57
10007550082	132-64 64 NIKKEL	8.57
10007550083	132-64 64 ANTIKOLT BRONZ	8.57
10007550100	138-192 192 MATT KRÓM	8.51
10007550101	138-192 192 NIKKEL	8.51
10007550120	145-160 160 MATT KRÓM	8.55
10007550121	145-160 160 NIKKEL	8.55
10007550130	153-160 160 MATT KRÓM	8.55
10007550131	153-160 160 NIKKEL	8.55
10007550140	153-128 128 MATT KRÓM	8.55
10007550141	153-128 128 NIKKEL	8.55
10007550150	154-160 160 MATT KRÓM	8.54
10007550151	154-160 160 NIKKEL	8.54
10007550180	169-160 160 MATT KRÓM	8.51
10007550181	169-160 160 NIKKEL	8.51
10007550190	169-128 128 MATT KRÓM	8.51
10007550191	169-128 128 NIKKEL	8.51
10007550200	180-128 128 MATT KRÓM	8.51
10007550201	180-128 128 NIKKEL	8.51
10007550246	M01.10.00.D1G 96 ANTIK FIRENZE-KŐMINTA	8.138
10007550247	M01.01.B1.D1G 96 ANTIK FIRENZE-BARNA MOTÍVUM	8.138
10007550250	M01.01.02.04 96 ANTIKOLT BRONZ-BARNA VIRÁG	8.138
10007550251	M01.01.12.04 96 ANTIKOLT BRONZ-SZÜRKE VIRÁG	8.138
10007550252	M01.01.00.15 96 ANTIKOLT EZÜST MINTA NÉLKÜL	8.138
10007550253	M01.01.20.04 96 ANTIKOLT BRONZ-ZÖLD VIRÁG	8.138
10007550254	M01.01.25.04 96 ANTIKOLT BRONZ-KÉK VIRÁG	8.138
10007550256	M01.01.01.04 96 ANTIKOLT BRONZ-SZÍNES VIRÁG	8.138
10007550257	M01.01.81.04 96 ANTIKOLT BRONZ-BÚZAKALÁSZ	8.138
10007550258	M01.01.90.B1G 96 COUNTRY BRONZ-KÉK MOTÍVUM	8.138
10007550259	M01.01.02.B1G 96 COUNTRY BRONZ-BARNA VIRÁG	8.138
10007550260	P01.01.02.04 41,5X33,5 ANTIKOLT BRONZ-BARNA VIRÁG	8.141
10007550264	P01.01.01.04 41,5X33,5 ANTIKOLT BRONZ-SZÍNES VIRÁG	8.141
10007550265	P01.01.81.04 41,5X33,5 ANTIKOLT BRONZ-BÚZAKALÁSZ	8.141
10007550270	P03.01.02.04 ÁTM:35 ANTIKOLT BRONZ-BARNA VIRÁG	8.141
10007550271	P03.01.20.04 ÁTM:35 ANTIKOLT BRONZ-ZÖLD VIRÁG	8.141
10007550272	P03.01.25.04 ÁTM:35 ANTIKOLT BRONZ-KÉK VIRÁG	8.141
10007550274	P03.01.01.04 ÁTM:35 ANTIKOLT BRONZ-SZÍNES VIRÁG	8.141
10007550275	P03.01.81.04 ÁTM:35 ANTIKOLT BRONZ-BÚZAKALÁSZ	8.141
10007550278	P07.01.90.B1G ÁTM:34 COUNTRY BRONZ-KÉK MOTÍVUM	8.142
10007550279	P07.01.02.B1G ÁTM:34 COUNTRY BRONZ-BARNA VIRÁG	8.142
10007550280	P07.01.02.04 ÁTM:34 ANTIKOLT BRONZ-BARNA VIRÁG	8.142
10007550281	P07.01.20.04 ÁTM:34 ANTIKOLT BRONZ-ZÖLD VIRÁG	8.142

Cikkszám	Típus	Oldal
10007550282	P07.01.25.04 ÁTM:34 ANTIKOLT BRONZ-KÉK VIRÁG	8.142
10007550283	P07.01.12.04 ÁTM:34 ANTIKOLT BRONZ-SZÜRKE VIRÁG	8.142
10007550284	P07.01.01.04 ÁTM:34 ANTIKOLT BRONZ-SZÍNES VIRÁG	8.142
10007550285	P07.01.81.04 ÁTM:34 ANTIKOLT BRONZ-BÚZAKALÁSZ	8.142
10007550286	P07.10.00.D1G ÁTM:34 ANTIK FIRENZE-KŐMINTA	8.142
10007550287	P07.01.B1.D1G ÁTM:34 ANTIK FIRENZE-BARNA MOTÍVUM	8.142
10007550288	P07.01.A1.D1G ÁTM:34 ANTIK FIRENZE-ARANYFÜST	8.142
10007550289	P07.21.22.D1G ÁTM:34 ANTIK FIRENZE-BORDÓ-ARANYKOSZORÚ	8.142
10007550290	P08.01.02.04 ÁTM:29 ANTIKOLT BRONZ-BARNA VIRÁG	8.142
10007550291	P08.01.20.04 ÁTM:29 ANTIKOLT BRONZ-ZÖLD VIRÁG	8.142
10007550292	P08.01.25.04 ÁTM:29 ANTIKOLT BRONZ-KÉK VIRÁG	8.142
10007550293	P08.01.12.04 ÁTM:29 ANTIKOLT BRONZ-SZÜRKE VIRÁG	8.142
10007550294	P08.01.01.04 ÁTM:29 ANTIKOLT BRONZ-SZÍNES VIRÁG	8.142
10007550295	P08.01.81.04 ÁTM:29 ANTIKOLT BRONZ-BÚZAKALÁSZ	8.142
10007550308	M10.01.90.B1G 96 COUNTRY BRONZ-KÉK MOTÍVUM	8.138
10007550309	M10.01.02.B1G 96 COUNTRY BRONZ-BARNA VIRÁG	8.138
10007550310	M10.01.20.04 96 ANTIKOLT BRONZ-ZÖLD VIRÁG	8.138
10007550311	M10.01.25.04 96 ANTIKOLT BRONZ-KÉK VIRÁG	8.138
10007550312	M10.01.12.04 96 ANTIKOLT BRONZ-SZÜRKE VIRÁG	8.138
10007550313	M10.01.01.04 96 ANTIKOLT BRONZ-SZÍNES VIRÁG	8.138
10007550314	M10.01.02.04 96 ANTIKOLT BRONZ-BARNA VIRÁG	8.138
10007550315	M10.01.81.04 96 ANTIKOLT BRONZ-BÚZAKALÁSZ	8.138
10007550316	M10.10.00.D1G 96 ANTIK FIRENZE-KŐMINTA	8.138
10007550317	M10.01.B1.D1G 96 ANTIK FIRENZE-BARNA MOTÍVUM	8.138
10007550318	M10.01.A1.D1G 96 ANTIK FIRENZE-ARANYFÜST	8.138
10007550319	M10.21.22.D1G 96 ANTIK FIRENZE-BORDÓ-ARANYKOSZORÚ	8.138
10007550330	M17.01.02.04 96/128 ANTIKOLT BRONZ-BARNA VIRÁG	8.139
10007550331	M17.01.81.04 96/128 ANTIKOLT BRONZ-BÚZAKALÁSZ	8.139
10007550332	M17.01.90.B1G 96/128 COUNTRY BRONZ-KÉK MOTÍVUM	8.139
10007550335	M17.01.B1.D1G 96/128 ANTIK FIRENZE-BARNA MOTÍVUM	8.139
10007550340	M50.01.02.04 96 ANTIKOLT BRONZ-BARNA VIRÁG	8.139
10007550341	M50.01.81.04 96 ANTIKOLT BRONZ-BÚZAKALÁSZ	8.139
10007550343	M50.01.02.B1G 96 COUNTRY BRONZ-BARNA VIRÁG	8.139
10007550344	M50.10.00.D1G 96 ANTIK FIRENZE-KŐMINTA	8.139

Cikkszám	Típus	Oldal
10007550345	M50.01.B1.D1G 96 ANTIK FIRENZE-BARNA MOTÍVUM	8.139
10007550360	P04.01.20.04 31 ANTIKOLT BRONZ-ZÖLD VIRÁG	8.141
10007550361	P04.01.25.04 31 ANTIKOLT BRONZ-KÉK VIRÁG	8.141
10007550364	P04.01.02.04 ÁTM:31 ANTIKOLT BRONZ-BARNA VIRÁG	8.141
10007550365	P04.01.81.04 ÁTM:31 ANTIKOLT BRONZ-BÚZAKALÁSZ	8.141
10007550372	P10.01.00.06 ÁTM:35 ARANY-TÖRTFEHÉR	8.151
10007550373	P10.00.00.06 ÁTM:35 FEHÉR-RÉZ	8.151
10007550435	P23.10.00.04 ÁTM:62 ANTIKOLT BRONZ-KŐMINTA	8.143
10007550436	P23.01.00.04 ÁTM:62 ANTIKOLT BRONZ-TÖRT FEHÉR	8.143
10007550440	P18.01.02.B1G 57x34 COUNTRY BRONZ-BARNA VIRÁG	8.143
10007550490	M22.01.B1.D1G 96 ANTIK FIRENZE-BARNA MOTÍVUM	8.139
10007550500	2025-25 Átm:25 ANTIKOLT BRONZ	8.118
10007550501	2025-25 Átm:25 NIKKEL	8.118
10007550510	2025-35 Átm:35 ANTIKOLT BRONZ	8.118
10007550511	2025-35 Átm:35 NIKKEL	8.118
10007550520	5021/A Átm:57 ANTIKOLT BRONZ	8.118
10007550530	5059 22X64 ANTIKOLT BRONZ	8.118
10007550540	5042/A 96 ANTIKOLT BRONZ	8.118
10007550550	5042/B 64 ANTIKOLT BRONZ	8.118
10007550560	5091 64 ANTIKOLT BRONZ	8.117
10007550580	5031/B 64 ANTIKOLT BRONZ	8.118
10007550590	5031/A 96 ANTIKOLT BRONZ	8.118
10007550600	504-96 96 ANTIKOLT BRONZ	8.110
10007550610	504-32 32 ANTIKOLT BRONZ	8.110
10007550620	503-96 96 ANTIKOLT BRONZ	8.111
10007550621	503-96 96 ANTIKOLT EZÜST	8.111
10007550630	503-000 44x25 ANTIKOLT BRONZ	8.111
10007550631	503-000 44x25 ANTIKOLT EZÜST	8.111
10007550640	225-96 96 ANTIKOLT BRONZ	8.114
10007550650	225-16 16 ANTIKOLT BRONZ	8.114
10007550680	214-96 96 ANTIKOLT BRONZ	8.114
10007550690	114-000 35x24 ANTIKOLT BRONZ	8.112
10007550700	226-96 96 ANTIKOLT BRONZ	8.113
10007550710	226-24 24 ANTIKOLT BRONZ	8.113
10007550720	224-96 96 ANTIKOLT BRONZ	8.114
10007550721	224-96 96 NIKKEL	8.114
10007550730	224-16 16 ANTIKOLT BRONZ	8.114
10007550731	224-16 16 NIKKEL	8.114
10007550740	228-96 96 ANTIKOLT BRONZ	8.112
10007550750	231-96 96 ANTIKOLT BRONZ	8.113
10007550751	231-96 96 NIKKEL	8.113
10007550755	231-128 128 NIKKEL	8.113
10007550760	218-96 96 ANTIKOLT BRONZ	8.113
10007550770	118-000 44x22 ANTIKOLT BRONZ	8.112
10007550780	229-96 96 ANTIKOLT BRONZ	8.110
10007550790	229-30 29 ANTIKOLT BRONZ	8.110
10007550800	222-96 96 ANTIKOLT BRONZ	8.117
10007550810	222-32 32 ANTIKOLT BRONZ	8.117
10007550820	501-96 96 ANTIKOLT BRONZ	8.111
10007550821	501-96 96 ANTIKOLT EZÜST	8.111
10007550830	501-000 Átm:31 ANTIKOLT BRONZ	8.111

Cikkszám	Típus	Oldal
10007552222	655.016.KRD1 16 ANTIKOLT BRONZ-SWAROVSKI KRISTÁLY	8.92
10007552230	655.000.KR02 . KRÓM-SWAROVSKI KRISTÁLY	8.92
10007552231	655.000.KR03 . NIKKEL-SWAROVSKI KRISTÁLY	8.92
10007552232	655.000.KRD1 . ANTIKOLT BRONZ-SWAROVSKI KRISTÁLY	8.92
10007552240	694.000.KRP9 . NIKKEL-SWAROVSKI KRISTÁLY	8.91
10007552241	694.000.KRL8 . FEKETE NIKKEL-SWAROVSKI KRISTÁLY	8.91
10007552250	694.096.KRP9 . NIKKEL-SWAROVSKI KRISTÁLY	8.91
10007552251	694.096.KRL8 . FEKETE NIKKEL-SWAROVSKI KRISTÁLY	8.91
10007552260	694.128.KRP9 . NIKKEL-SWAROVSKI KRISTÁLY	8.91
10007552261	694.128.KRL8 . FEKETE NIKKEL-SWAROVSKI KRISTÁLY	8.91
10007552270	694.160.KRP9 . NIKKEL-SWAROVSKI KRISTÁLY	8.91
10007552271	694.160.KRL8 . FEKETE NIKKEL-SWAROVSKI KRISTÁLY	8.91
10007552280	693.015.KR03 . NIKKEL-SWAROVSKI KRISTÁLY	8.89
10007552281	693.015.KRE2 . FEKETE NIKKEL-SWAROVSKI KRISTÁLY	8.89
10007552290	693.031.KR03 . NIKKEL-SWAROVSKI KRISTÁLY	8.89
10007552291	693.031.KRE2 . FEKETE NIKKEL-SWAROVSKI KRISTÁLY	8.89
10007552300	693.032.KR03 . NIKKEL-SWAROVSKI KRISTÁLY	8.90
10007552301	693.032.KRE2 . FEKETE NIKKEL-SWAROVSKI KRISTÁLY	8.90
10007552310	693.096.KR03 . NIKKEL-SWAROVSKI KRISTÁLY	8.90
10007552311	693.096.KRE2 . FEKETE NIKKEL-SWAROVSKI KRISTÁLY	8.90
10007552320	693.128.KR03 . NIKKEL-SWAROVSKI KRISTÁLY	8.90
10007552321	693.128.KRE2 . FEKETE NIKKEL-SWAROVSKI KRISTÁLY	8.90
10007552330	667.016.KR03 . NIKKEL-SWAROVSKI KRISTÁLY	8.90
10007552331	667.016.KRE2 . FEKETE NIKKEL-SWAROVSKI KRISTÁLY	8.90
10007552350	667.096.KR03 . NIKKEL-SWAROVSKI KRISTÁLY	8.91
10007552351	667.096.KRE2 . FEKETE NIKKEL-SWAROVSKI KRISTÁLY	8.91
10007552360	667.128.KR03 . NIKKEL-SWAROVSKI KRISTÁLY	8.91
10007552361	667.128.KRE2 . FEKETE NIKKEL-SWAROVSKI KRISTÁLY	8.91
10007552370	580.224.00M2 . FÉNYES ELEFÁNTCSONT	8.50
10007552371	580.224.00R3 . EZÜST	8.50
10007552372	580.224.0002 . KRÓM	8.50
10007552380	0006.192.0003 . NIKKEL	8.50
10007552381	0006.192.0002 . KRÓM	8.50
10007552382	0006.192.0001 . MATT KRÓM	8.50
10007552390	187.096.0003 . NIKKEL	8.50
10007552391	187.096.0001 . MATT KRÓM	8.50
10007552400	187.160.0003 . NIKKEL	8.50
10007552401	187.160.0001 . MATT KRÓM	8.50

Cikkszám	Típus	Oldal
10007552410	187.224.0003 . NIKKEL	8.50
10007552411	187.224.0001 . MATT KRÓM	8.50
10007552420	719.000.00D1 . ANTIK FIRENZE	8.124
10007552421	719.000.00T5 . ANTIKOLT KRÉM-ARANY	8.124
10007552430	719.128.00D1 . ANTIK FIRENZE	8.123
10007552431	719.128.00T5 . ANTIKOLT KRÉM-ARANY	8.123
10007552440	711.064.00D1 . ANTIK FIRENZE	8.123
10007552441	711.064.00T5 . ANTIKOLT KRÉM-ARANY	8.123
10007552450	712.000.00D1 . ANTIK FIRENZE	8.124
10007552451	712.000.00T5 . ANTIKOLT KRÉM-ARANY	8.124
10007552460	706.035.00D1 . ANTIK FIRENZE	8.124
10007552461	706.035.00T5 . ANTIKOLT KRÉM-ARANY	8.124
10007552462	706.035.00R3 . EZÜST	8.124
10007552470	M70.01.G2.T5G . ANTIKOLT KRÉM-ARANY	8.140
10007552471	P88.01.G2.T5G . ANTIKOLT KRÉM-ARANY	8.144
10007552480	M70.01.G6.B1G . COUNTRY BRONZ-BARNA VIRÁG	8.140
10007552481	P88.01.G6.B1G . COUNTRY BRONZ-BARNA VIRÁG	8.144
10007552490	M70.01.G2.D1G . ANTIK FIRENZE-ARANY VIRÁG	8.140
10007552491	P88.01.G2.D1G . ANTIK FIRENZE-ARANY VIRÁG	8.144
10007552500	752.000.00D1 . ANTIK FIRENZE	8.115
10007552510	752.096.00D1 96 ANTIK FIRENZE	8.115
10007552520	752.128.00D1 128 ANTIK FIRENZE	8.115
10007552530	752.160.00D1 160 ANTIK FIRENZE	8.115
10007552540	740.031.00D1 . ANTIK FIRENZE	8.122
10007552550	740.096.00D1 96 ANTIK FIRENZE	8.122
10007552560	740.128.00D1 128 ANTIK FIRENZE	8.122
10007552570	124.128.0001 128 MATT ALUMINIUM	8.56
10007552571	124.128.0003 128 NIKKEL	8.56
10007552580	555.096.00D1 96 ANTIK FIRENZE	8.115
10007552590	555.128.00D1 128 ANTIK FIRENZE	8.115
10007552600	555.160.00D1 160 ANTIK FIRENZE	8.115
10007552610	126.064.00K1 64 PLATINA NIKKEL	8.51
10007552620	126.128.00K1 128 PLATINA NIKKEL	8.51
10007552630	552.128.00K1 128 PLATINA NIKKEL	8.56
10007552640	552.128.00K2 128 PLATINA ARANY	8.56
10007552650	WMN604.128.00N6 128 MATT PLATINA	8.119
10007552651	WMN604.128.00G7 128 BARNA	8.119
10007552660	WMN604.096.00N6 096 MATT PLATINA	8.119
10007552661	WMN604.096.00G7 096 BARNA	8.119
10007552670	WPO604.032.00N6 GOMB, 032MM MATT PLATINA	8.119
10007552671	WPO604.032.00G7 GOMB, 032MM BARNA	8.119
10007552680	WMN761.192.00C7 192 ANTIK ÓN	8.127
10007552681	WMN761.192.00T2.192 ANTIK FEKETE	8.127
10007552690	WMN761.160.00C7 160 ANTIK ÓN	8.127
10007552691	WMN761.160.00T2 160 ANTIK FEKETE	8.127
10007552700	WMN761.128.00C7 128 ANTIK ÓN	8.127

Cikkszám	Típus	Oldal
10007552701	WMN761.128.00T2 128 ANTIK FEKETE	8.127
10007552710	WMN761.096.00C7 096 ANTIK ÓN	8.127
10007552711	WMN761.096.00T2 096 ANTIK FEKETE	8.127
10007552720	WPO761.000.00C7 GOMB, 32MM ANTIK ÓN	8.127
10007552721	WPO761.000.00T2 GOMB, 32MM ANTIK FEKETE	8.127
10007552730	WMN772.320.00N6 320 MATT PLATINA	8.53
10007552731	WMN772.320.00C7 320 ANTIK ÓN	8.53
10007552732	WMN772.320.00T2 320 ANTIK FEKETE	8.53
10007552740	WMN772.192.00N6 192 MATT PLATINA	8.53
10007552741	WMN772.192.00C7 192 ANTIK ÓN	8.53
10007552742	WMN772.192.00T2 192 ANTIK FEKETE	8.53
10007552750	WMN772.160.00N6 160 MATT PLATINA	8.53
10007552751	WMN772.160.00C7 160 ANTIK ÓN	8.53
10007552752	WMN772.160.00T2 160 ANTIK FEKETE	8.53
10007552760	WMN772.128.00N6 128 MATT PLATINA	8.53
10007552761	WMN772.128.00C7 128 ANTIK ÓN	8.53
10007552762	WMN772.128.00T2 128 ANTIK FEKETE	8.53
10007552770	WMN772.096.00N6 096 MATT PLATINA	8.53
10007552771	WMN772.096.00C7 096 ANTIK ÓN	8.53
10007552772	WMN772.096.00T2 096 ANTIK FEKETE	8.53
10007552780	WMN776.160.00T2 160 ANTIK FEKETE	8.129
10007552790	WCR100.019.00T2 DÍSZPÁNT / 19 MM ANTIK FEKETE	8.129
10007552800	WMN777.032.00T2 032 ANTIK FEKETE	8.129
10007552810	WMN784.160.00C7 160 ANTIK ÓN	8.128
10007552811	WMN784.160.00T2 160 ANTIK FEKETE	8.128
10007552820	WMN784.128.00C7 128 ANTIK ÓN	8.128
10007552821	WMN784.128.00T2 128 ANTIK FEKETE	8.128
10007552830	WMN784.096.00C7 096 ANTIK ÓN	8.128
10007552831	WMN784.096.00T2 096 ANTIK FEKETE	8.128
10007552840	WPO784.017.00C7 GOMB, 17MM ANTIK ÓN	8.128
10007552841	WPO784.017.00T2 GOMB, 17MM ANTIK FEKETE	8.128
10007552850	WMN785.160.00C5 160 ANTIK RÉZ	8.126
10007552851	WMN785.160.00T2 160 ANTIK FEKETE	8.126
10007552860	WMN785.128.00C5 128 ANTIK RÉZ	8.126
10007552861	WMN785.128.00T2 128 ANTIK FEKETE	8.126
10007552870	WMN785.096.00C5 096 ANTIK RÉZ	8.126
10007552871	WMN785.096.00T2 092 ANTIK FEKETE	8.126
10007552880	WPO785.000.00C5 GOMB, 15MM ANTIK RÉZ	8.126
10007552881	WPO785.000.00T2 GOMB, 15MM ANTIK FEKETE	8.126

Cikkszám	Típus	Oldal
10007552890	WMN786.160.00N4 160 MATT FEKETE	8.126
10007552891	WMN786.160.00F3 160 ARANY	8.126
10007552900	WPO786.016.00N4 GOMB, 016MM MATT FEKETE	8.126
10007552901	WPO786.016.00F3 GOMB, 016MM ARANY	8.126
10007552910	WMN787.320.00N6 320 MATT PLATINA	8.52
10007552911	WMN787.320.00C7 320 ANTIK ÓN	8.52
10007552912	WMN787.320.00T2 320 ANTIK FEKETE	8.52
10007552920	WMN787.192.00N6 192 MATT PLATINA	8.52
10007552921	WMN787.192.00C7 192 ANTIK ÓN	8.52
10007552922	WMN787.192.00T2 192 ANTIK FEKETE	8.52
10007552930	WMN787.160.00N6 160 MATT PLATINA	8.52
10007552931	WMN787.160.00C7 160 ANTIK ÓN	8.52
10007552932	WMN787.160.00T2 160 ANTIK FEKETE	8.52
10007552940	WMN787.128.00N6 128 MATT PLATINA	8.52
10007552941	WMN787.128.00C7 128 ANTIK ÓN	8.52
10007552942	WMN787.128.00T2 128 ANTIK FEKETE	8.52
10007552950	WMN787.096.00N6 096 MATT PLATINA	8.52
10007552951	WMN787.096.00C7 096 ANTIK ÓN	8.52
10007552952	WMN787.096.00T2 096 ANTIK FEKETE	8.52
10007552960	WMN762.160.00D1 160 ANTIK FIRENZE	8.122
10007552970	WMN762.128.00D1 128 ANTIK FIRENZE	8.122
10007552980	WMN762.096.00D1 096 ANTIK FIRENZE	8.122
10007552990	WPO762.000.00D1 GOMB, 32MM ANTIK FIRENZE	8.122
10007553000	WMN780.160.00D1 160 ANTIK FIRENZE	8.125
10007553001	WMN780.160.00T2 160 ANTIK FEKETE	8.125
10007553010	WMN780.128.00D1 128 ANTIK FIRENZE	8.125
10007553011	WMN780.128.00T2 128 ANTIK FEKETE	8.125
10007553020	WMN780.096.00D1 096 ANTIK FIRENZE	8.125
10007553021	WMN780.096.00T2 096 ANTIK FEKETE	8.125
10007553025	WPO780.000.00D1 GOMB, 28x28x24 MM ANTIK FIRENZE	8.125
10007553026	WPO780.000.00T2 GOMB, 28x28x24 MM ANTIK FEKETE	8.125
10007553030	P77.01.Q3.D1G GOMB, 35MM ANTIK FIRENZE VINTAGE	8.143
10007553031	P77.01.Q4.D1G GOMB, 35MM ANTIK FIRENZE PARIS	8.143
10007553032	P77.00.Q3.G7G GOMB, 35MM BARNA VINTAGE	8.143
10007553033	P77.00.Q4.G7G GOMB, 35MM BARNA PARIS	8.143
10007553040	M94.01.Q3.D1G 128 ANTIK FIRENZE VINTAGE	8.140
10007553041	M94.01.Q4.D1G 128 ANTIK FIRENZE PARIS	8.140

Cikkszám	Típus	Oldal
10007553042	M94.00.Q3.G7G 128 BARNA VINTAGE	8.140
10007553043	M94.00.Q4.G7G 128 BARNA PARIS	8.140
10007553050	M95.01.Q3.D1G 096 ANTIK FIRENZE VINTAGE	8.140
10007553051	M95.01.Q4.D1G 096 ANTIK FIRENZE PARIS	8.140
10007553052	M95.00.Q3.G7G 096 BARNA VINTAGE	8.140
10007553053	M95.00.Q4.G7G 096 BARNA PARIS	8.140
10007590040	MB09078B0 56X63X69 MM PATAGÓNIA EZÜST	8.37
10007590050	MB09107B0 46X52X56 MM PATAGÓNIA EZÜST	8.35
10007590070	MB09045A0 96X108X110,5 MM PATAGÓNIA EZÜST	8.37
10007590080	MB09132B0 55 MM PATAGÓNIA EZÜST	8.37
10007590081	MB09132B0 55 MM CALEDONIA NIKKEL	8.37
10007590110	MB091020M 280 MM PRETORIA KRÓM	8.35
10007590111	MB091020M 280 MM BOTSWANA NIKKEL	8.35
10007590120	MB09142B0 50X50 MM PATAGÓNIA EZÜST	8.36
10007590121	MB09142B0 50X50 MM CALEDONIA NIKKEL	8.36
10007590122	MB09142B0 50X50 MM MATT FEHÉR	8.36
10007590130	MB0914300 . PATAGÓNIA EZÜST	8.36
10007590131	MB0914300 . CALEDONIA NIKKEL	8.36
10007590132	MB0914300 . MATT FEHÉR	8.36
10007590140	MB0914400 . PATAGÓNIA EZÜST	8.36
10007590141	MB0914400 . CALEDONIA NIKKEL	8.36
10007590142	MB0914400 . MATT FEHÉR	8.36
10007590150	MB09148A0 . PATAGÓNIA EZÜST	8.35
10007590151	MB09148A0 . MATT FEHÉR	8.35
10007601321	T241-96 96 MATT FEKETE	8.73
10007601322	T241-96 96 MATT KRÓM	8.73
10007601333	T243-96 96 KRÓM	8.71
10007601334	T243-96 96 MATT KRÓM	8.71
10007601335	T243-96 96 MATT NIKKEL	8.71
10007601339	T244-64 64 KRÓM	8.72
10007601340	T244-64 64 MATT NIKKEL	8.72
10007601343	T244-96 96 KRÓM	8.72
10007601344	T244-96 96 MATT KRÓM	8.72
10007601345	T244-96 96 MATT NIKKEL	8.72
10007601346	T244-96 96 ARANY	8.72
10007601375	T250-96 96 MATT KRÓM	8.69
10007601376	T250-96 96 MATT NIKKEL	8.69
10007601379	T250-128 128 MATT KRÓM	8.69
10007601380	T250-128 128 MATT NIKKEL	8.69
10007601389	T252-28 28 KRÓM	8.69
10007601390	T252-28 28 MATT KRÓM	8.69
10007601393	T252-28 28 MATT NIKKEL	8.69
10007601396	T253-96 96 KRÓM	8.69
10007601397	T253-96 96 MATT KRÓM	8.69
10007601398	T253-96 96 MATT NIKKEL	8.69
10007602300	T204-96 96 KRÓM	8.70
10007602400	T204-96 96 MATT NIKKEL	8.70
10007602500	T204-96 96 ARANY	8.70
10007606422	T229-76 76 ANTIKOLT BRONZ	8.101

Cikkszám	Típus	Oldal
10007606428	T231-92 GOMB ANTIKOLT BRONZ	8.101
10007606429	T232-96 96 KRÓM	8.70
10007606430	T232-96 96 MATT KRÓM	8.70
10007606431	T232-96 96 ARANY	8.70
10007606432	T232-128 128 KRÓM	8.70
10007606433	T232-128 128 MATT KRÓM	8.70
10007606435	T233-96 96 KRÓM	8.74
10007606436	T233-96 96 ARANY	8.74
10007606437	T233-96 96 MATT NIKKEL	8.74
10007606438	T234-128 128 KRÓM	8.74
10007606440	T234-128 128 MATT NIKKEL	8.74
10007606470	T236-128 128 MATT KRÓM	8.71
10007606472	T236-128 128 NIKKEL	8.71
10007606484	T238-96 96 MATT KRÓM	8.71
10007606485	T238-96 96 MATT NIKKEL	8.71
10007607900	T306-26 GOMB KRÓM	8.84
10007608800	T402-38 GOMB FEHÉR-ARANY KÖR	8.151
10007609000	T404-35 GOMB FEHÉR	8.151
10007610000	T254-96 96 ANTIKOLT BRONZ	8.73
10007610001	T254-96 96 MATT FEKETE	8.73
10007610003	T254-96 96 ARANY	8.73
10007610004	T254-96 96 KRÓM	8.73
10007610005	T254-96 96 MATT KRÓM	8.73
10007610006	T254-96 96 MATT NIKKEL	8.73
10007610010	T255-128 128 MATT KRÓM	8.70
10007610011	T255-128 128 KRÓM	8.70
10007610012	T255-128 128 MATT NIKKEL	8.70
10007610021	T256-96 96 MATT KRÓM	8.72
10007610040	T258-96 96 MATT KRÓM	8.72
10007610041	T258-96 96 KRÓM	8.72
10007610042	T258-96 96 MATT NIKKEL	8.72
10007610051	T259-64 64 KRÓM	8.73
10007611000	T500 GOMB RÖZSASZÍN	8.162
10007611001	T500 GOMB KÉK	8.162
10007611002	T500 GOMB SÁRGA	8.162
10007611010	T501 GOMB SOKSZÍNŰ	8.162
10007611020	T502 GOMB SOKSZÍNŰ	8.162
10007611030	T504 GOMB SOKSZÍNŰ	8.161
10007611040	T505 GOMB SOKSZÍNŰ	8.161
10007611050	T506 GOMB FEHÉR-FEKETE	8.162
10007611060	T507 GOMB BARNA	8.161
10007611070	T508 GOMB ZÖLD	8.161
10007611080	T509 GOMB SZÜRKE	8.160
10007611090	T510 GOMB PIROS	8.160
10007611100	T511 96/119 SÁRGA	8.162
10007611110	T511 96/119 KÉK	8.162
10007611130	T513 . FEKETE-FEHÉR	8.160
10007611140	T514 . SZÜRKE	8.160
10007650000	A001-096/146 96 ALUMÍNÍUM	8.19
10007650010	A001-128/178 128 ALUMÍNÍUM	8.19
10007650020	A001-160/210 160 ALUMÍNÍUM	8.19
10007650030	A001-192/242 192 ALUMÍNÍUM	8.19
10007650040	A001-224/274 224 ALUMÍNÍUM	8.19
10007650043	A001-256/306 256 ALUMÍNÍUM	8.19
10007650046	A001-288/338 288 ALUMÍNÍUM	8.19
10007650050	A001-320/370 320 ALUMÍNÍUM	8.19
10007650053	A001-352/402 352 ALUMÍNÍUM	8.19
10007650056	A001-384/434 384 ALUMÍNÍUM	8.19

Cikkszám	Típus	Oldal
10008870010	PA0027100 90x110x60 PRETORIA KRÓM	8.192
10008870011	PA0027100 90x110x60 BOTSWANA NIKKEL	8.192
10008870012	PA0027100 90x110x60 PATAGÓNIA EZÜST	8.192
10008870020	PA0027200 34,3x62,5x31,2 PRETORIA KRÓM	8.192
10008870021	PA0027200 34,3x62,5x31,2 BOTSWANA NIKKEL	8.192
10008870022	PA0027200 34,3x62,5x31,2 PATAGÓNIA EZÜST	8.192
10008870031	PA0027400 102x110x50 ROGALAND FÉM	8.193
10008870032	PA0027400 102x110x50 PATAGÓNIA EZÜST	8.193
10008870050	PA0028200 120x107x74 PRETORIA KRÓM	8.193
10008870051	PA0028200 120x107x74 BOTSWANA NIKKEL	8.193
10008870052	PA0028200 120x107x74 PATAGÓNIA EZÜST	8.193
10008870091	LID014800 100x30,4x56,2 CALEDÓNIA NIKKEL	8.194
10008871000	WAP801.000.00AN 85x138x50mm ANTIK NIKKEL	8.209
10008871010	WAP802.000.00AN 62x73mm ANTIK NIKKEL	8.209
10008903419	300 4 TŰSKÉVEL 160 OLASZ ALMA	8.225

Cikkszám	Típus	Oldal
10008903427	380 5 TŰSKÉVEL 240 OLASZ ALMA	8.225
10008903435	380 5 TŰSKÉVEL 240 BÜKK	8.225
10008903459	380 5 TŰSKÉVEL 240 FEHÉR	8.225
10008903470	362 4 TŰSKÉVEL 180 FENYŐ	8.225
10008903475	450 5 TŰSKÉVEL 270 FENYŐ	8.225
10008903505	380 3 FOGASSAL 315 FEHÉR	8.226
10008903530	450 4 FOGASSAL 385 FEHÉR	8.226
10008903585	450 4 FOGASSAL 385 FEKETE	8.226
10008903589	300 KULCSTARTÓ 265 FEHÉR	8.226
10008903591	300 KULCSTARTÓ 265 FEHÉR-RÉZ	8.226
10008904020	1292 2 FOGASSAL 134x90 BÜKK-SZÜRKE	8.220
10008904030	1293 1 FOGASSAL 134x50 BÜKK-SZÜRKE	8.220
10008904040	1294 32 BÜKK-SZÜRKE	8.220
10008904231	S666-440 440 BÜKK	8.224
10008904232	S666-440 440 WENGE	8.224
10008905000	1603-240 ZN1 240 KRÓM	8.221
10008905010	1603-240 ZN4 240 MATT NIKKEL	8.221
10008905320	S592-420 HZ6 420 FENYŐ	8.225
10008905321	S592-420 HZ46 420 ALUMÍNÍUM	8.225
10008905340	8161 168 KÉK	8.222
10008905341	8161 168 RÓZSASZÍN	8.222
10008905342	8161 168 NARANCS	8.222
10008905351	8162 168 VILÁGOS KÉK	8.222
10008905352	8162 168 RÓZSASZÍN	8.222

Cikkszám	Típus	Oldal
10008905353	8162 168 NARANCS	8.222
10008905360	8163 240 MATT KRÓM-ÁTTETSZŐ	8.223
10008905370	8164 240 FEHÉR-KRÓM	8.223
10008905371	8164 240 MATT KRÓM-KRÓM	8.223
10008905372	8164 240 WENGE-KRÓM	8.223
10008905380	8164 VONAT 240 SOKSZÍNŰ	8.223
10008905381	8164 AUTÓ 240 SOKSZÍNŰ	8.223
10008905382	8164 TÚNDÉR 240 RÓZSASZÍN	8.223
10008905390	8177 VONAT 168 SOKSZÍNŰ	8.224
10008905391	8177 AUTÓ 168 SOKSZÍNŰ	8.224
10008905392	8177 TÚNDÉR 168 RÓZSASZÍN	8.224
10008905400	8165-100 VONAT 100x22 SOKSZÍNŰ	8.219
10008905401	8165-100 AUTÓ 100x22 SOKSZÍNŰ	8.219
10008905402	8165-100 TÚNDÉR 100x22 RÓZSASZÍN	8.219
10008905410	8167 168 RÓZSASZÍN	8.222
10008905411	8167 168 KÉK	8.222
10008905412	8167 168 NARANCS	8.222
10008905420	8168 168 KÉK	8.222
10008905421	8168 168 RÓZSASZÍN	8.222
10008905422	8168 168 NARANCS	8.222
10008905430	8170 400X52 FEKETE BŐRHATÁSÚ-KRÓM	8.223
10008905440	8171 400X50 BARNÁ BŐRHATÁSÚ-ALUMÍNÍUM	8.223

Z15 díszlécek, díszidomok

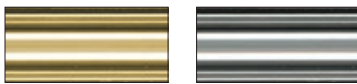

arany

ezüst



Z15-15

Z15-24

Z15-26

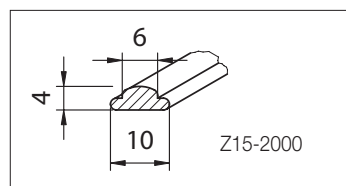

Z15-2000

díszlécek 2 m-es szájakban rendelhetők		
megnevezés	szín	cikkszám
Z15-2000 MF1 F	arany	10004001100
Z15-2000 MF2 F	ezüst	10004001400
díszidomok		
Z15-15 MT3	arany	10004100100
Z15-24 MT3	arany	10004100300
Z15-26 MT3	arany	10004100400

Z22 díszlécek



barna-arany



fekete-króm

fekete-matt acél

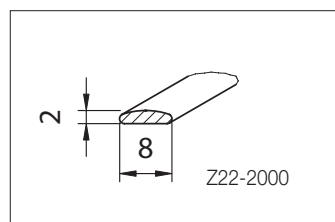

Z22-2000

Rugalmas díszléc

díszlécek - 2 m-es szájakban rendelhetők		
megnevezés	szín	cikkszám
Z22-2000 K2 MF1	barna-arany	10004001700
Z22-2000 K1 MF2	fekete-króm	10004001800
Z22-2000 K1 MF13	fekete-matt acél	10004001900